

1: 8.7 ←	Serie	39.0
2: 8.4 ↖		
3: 7.6 →		
4: 7.9 ↖		
5: 9.3 ↘		
Total		0.0

1: 7.5 ←	Serie	85.0
2: 9.6 ↓		
3: 9.4 ←		
4: 8.1 →		
5: 6.7 ↓		
6: 9.3 ↑	Serie	85.0
7: 9.9 →		
8: 9.9 ↑		
9: 9.1 ↖		
10: *10.4 ↓		
Total		85.0

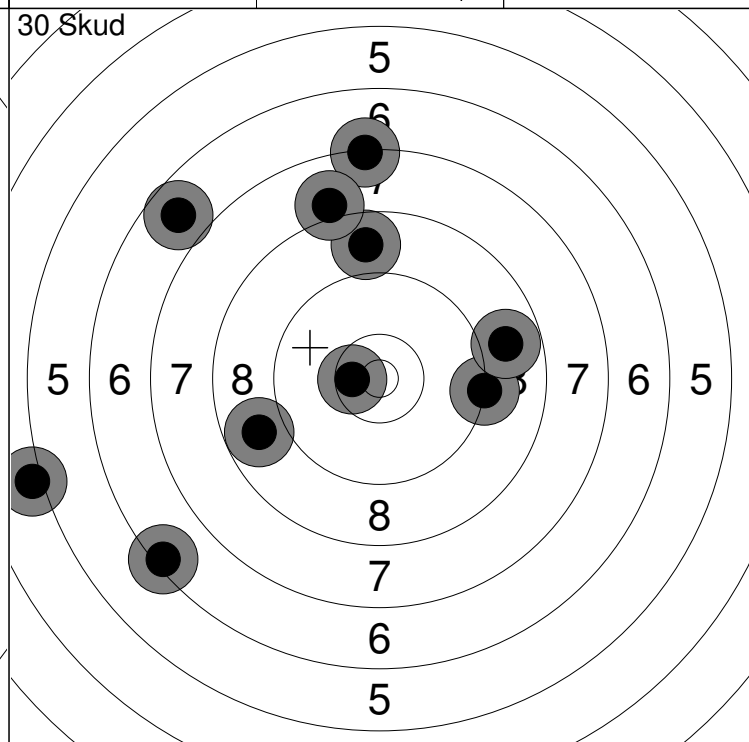
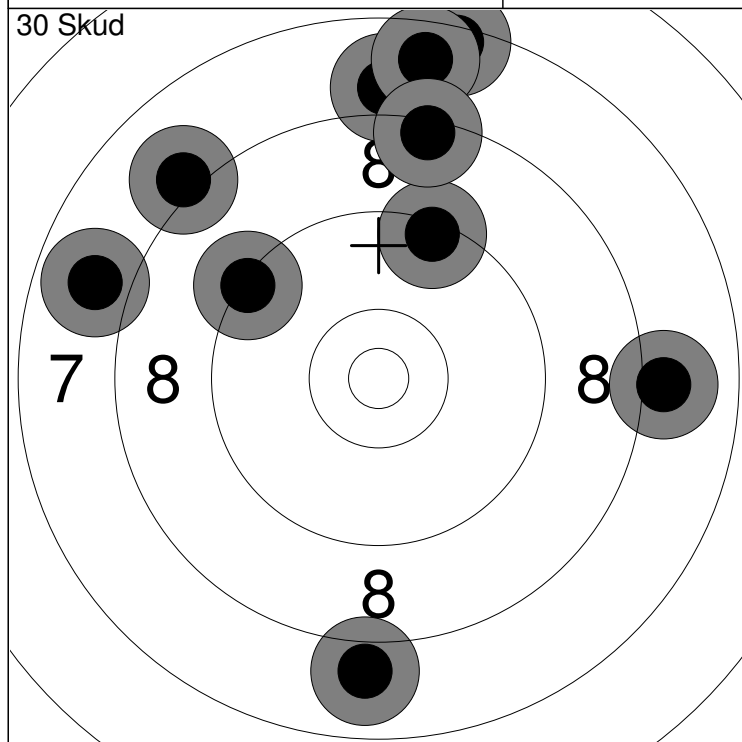

11: 8.0 →	16: 7.6 ↑	Serie	77.0
12: 7.4 ↑	17: 9.3 ↖		
13: 7.9 ↑	18: 7.9 ↓		
14: 7.9 ←	19: 8.4 ↑		
15: 9.4 ↑	20: 8.1 ↖		
Total			162.0

21: *10.5 ←	26: 9.2 →	Serie	75.0
22: 7.3 ↑	27: 8.8 ↑		
23: 8.8 ←	28: 8.0 ↑		
24: 6.7 ↖	29: 8.8 →		
25: 5.1 ←	30: 6.4 ↖		
Total			237.0

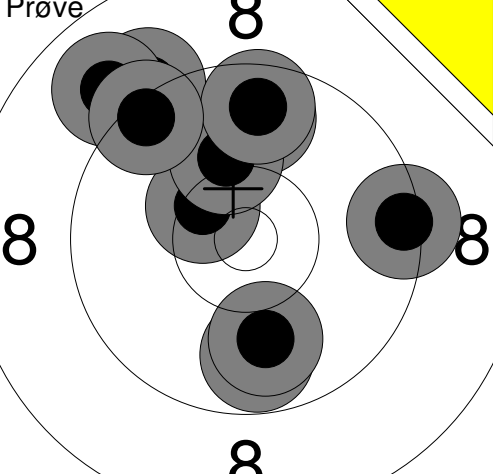
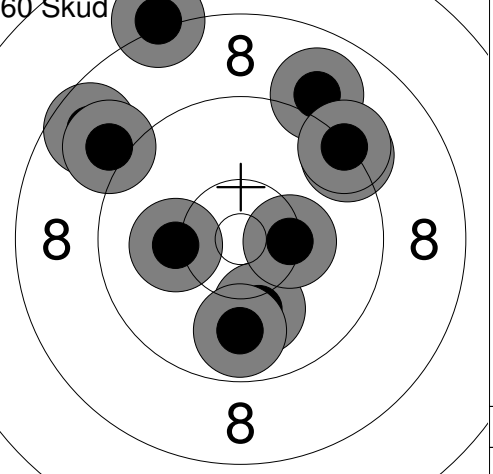
<p>Prøve</p> 	<p>1: *10.4 ↗ 2: 9.8 ↓ 3: 9.8 ↑ 4: 10.1 ↑ 5: 9.2 ↗ 6: 9.4 → 7: 9.0 ↗ 8: 9.6 ↑ 9: 9.4 ↗ 10: 10.0 ↓</p>	<p>60 Skud</p> 	<p>1: 10.2 ← 2: 9.0 ↗ 3: 10.1 ↓ 4: 8.7 ↗ 5: 9.3 ↗ 6: 8.1 ↑ 7: *10.4 → 8: 9.8 ↓ 9: 9.3 ↗ 10: 9.0 ↗</p>
Serie 93.0		Serie 91.0	
Total 0.0		Total 91.0	

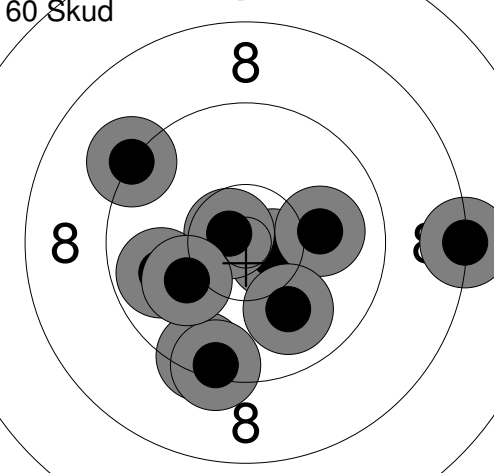
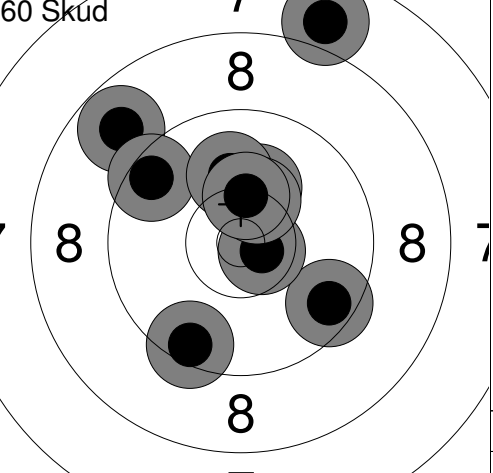
<p>60 Skud</p> 	<p>11: 9.2 ↗ 12: 9.5 ↓ 13: 9.4 ↓ 14: *10.6 ↘ 15: *10.7 ↗ 16: 10.0 → 17: 10.0 ↓ 18: 8.2 → 19: 9.8 ← 20: 10.1 ↙</p>	<p>60 Skud</p> 	<p>21: 9.6 ↘ 22: 10.2 ↑ 23: 9.5 ↓ 24: 8.8 ↗ 25: 9.5 ↗ 26: 10.1 ↑ 27: *10.7 ↘ 28: *10.4 ↑ 29: 10.3 ↑ 30: 7.9 ↑</p>
Serie 94.0		Serie 92.0	
Total 185.0		Total 277.0	

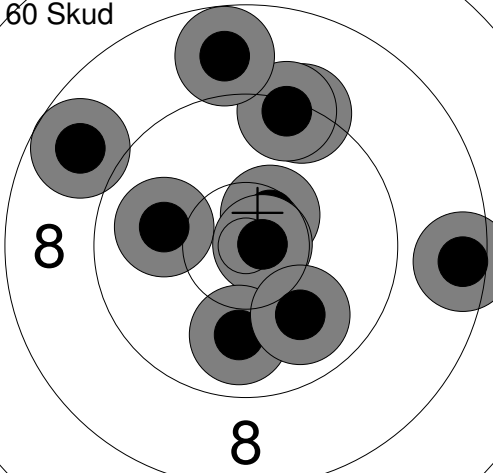
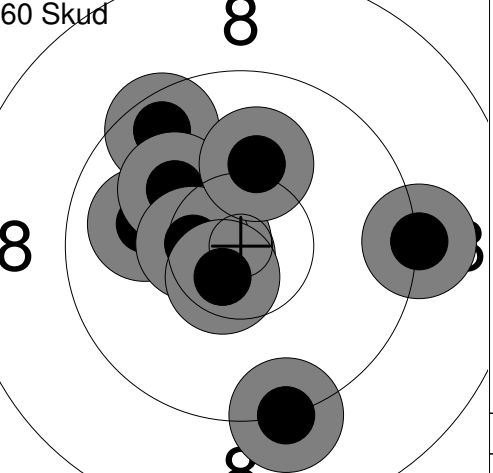

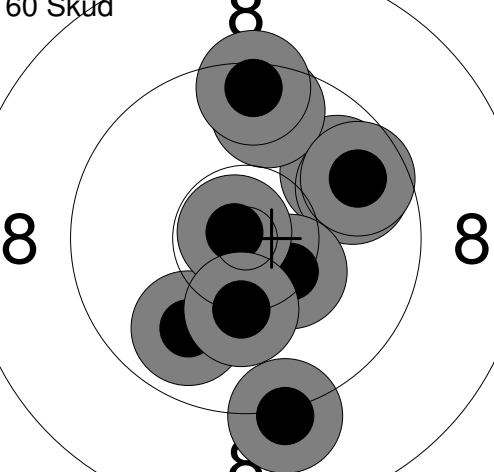
<p>60 Skud</p> 	<p>31: *10.5 ↗ 32: 10.0 ← 33: *10.8 → 34: 8.8 ↗ 35: 9.9 ↓ 36: 10.0 ↓ 37: 8.5 → 38: 9.3 ↑ 39: 9.4 ↑ 40: 8.8 ↑</p>	<p>60 Skud</p> 	<p>41: 9.6 ↗ 42: 10.0 ← 43: *10.7 ← 44: 9.2 → 45: 10.1 ↗ 46: *10.7 ← 47: 9.2 ↓ 48: *10.5 ← 49: 10.1 ↑ 50: *10.6 ↘</p>
Serie 91.0		Serie 97.0	
Total 368.0		Total 465.0	

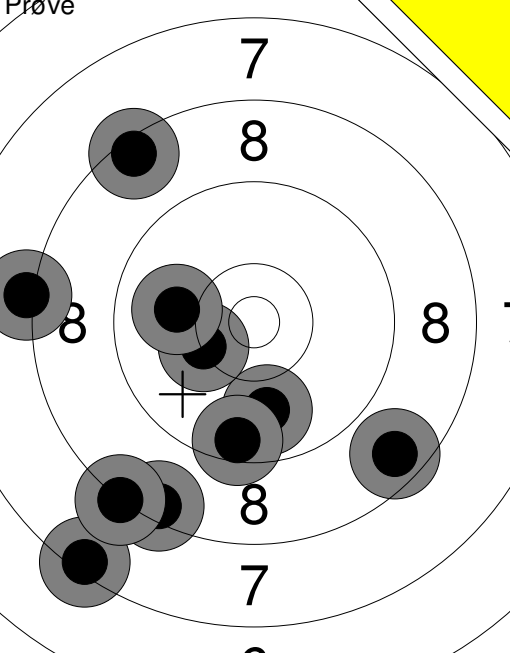
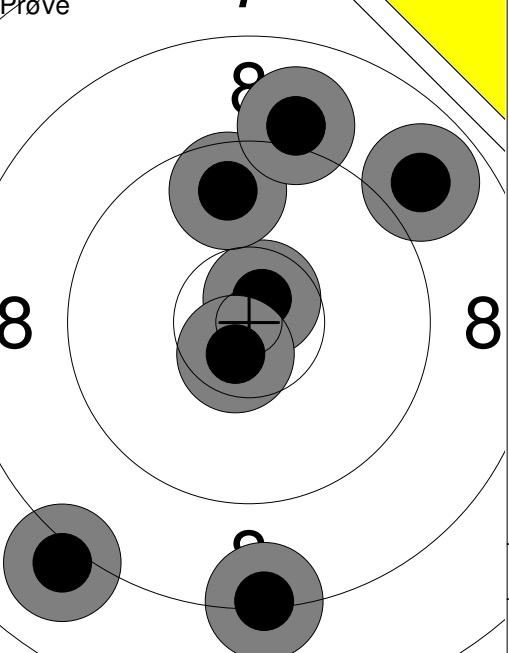
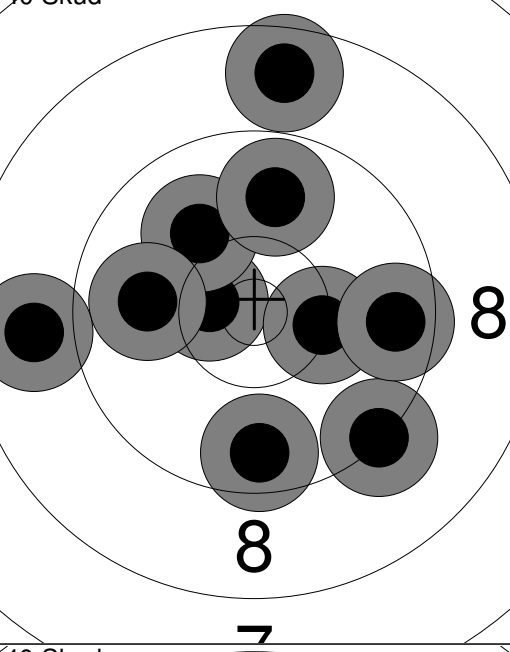
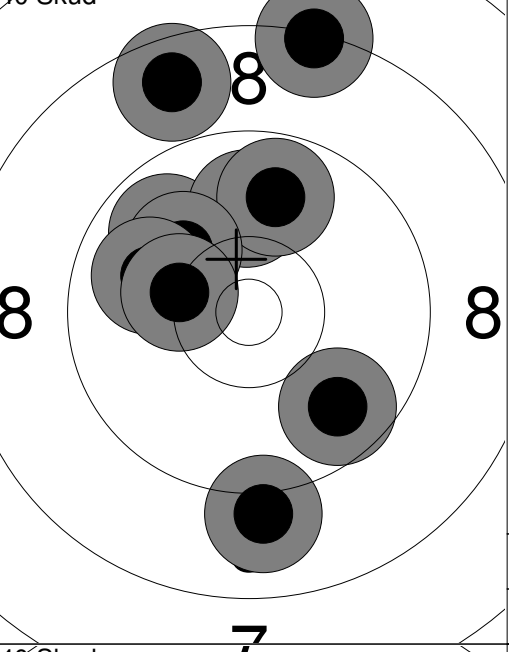
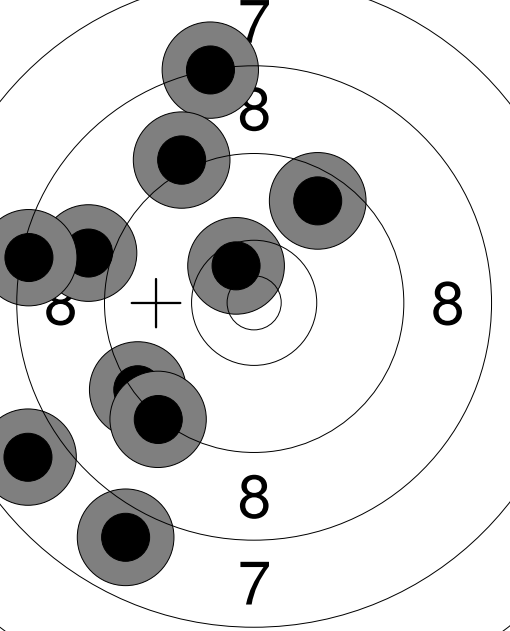
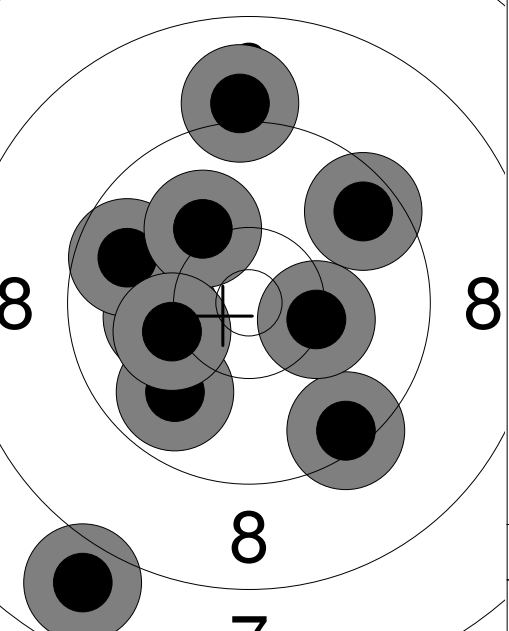
<p>60 Skud</p> 	<p>51: 9.8 ↗ 52: 9.7 ↑ 53: 9.8 ↗ 54: *10.4 ↘ 55: 9.9 ↘ 56: 9.7 ↗ 57: *10.8 ↗ 58: 10.3 ↓ 59: 9.2 ↓ 60: 9.5 ↑</p>		
Serie 93.0			
Total 558.0			

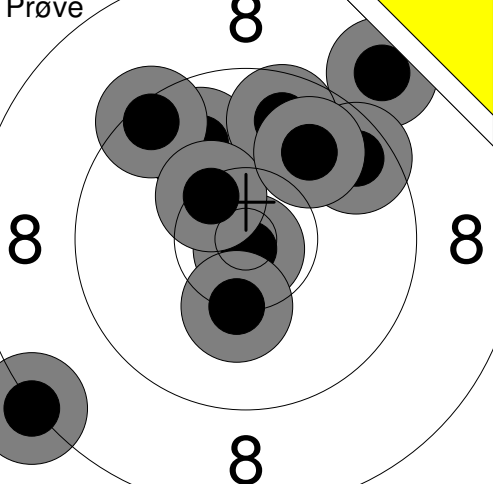
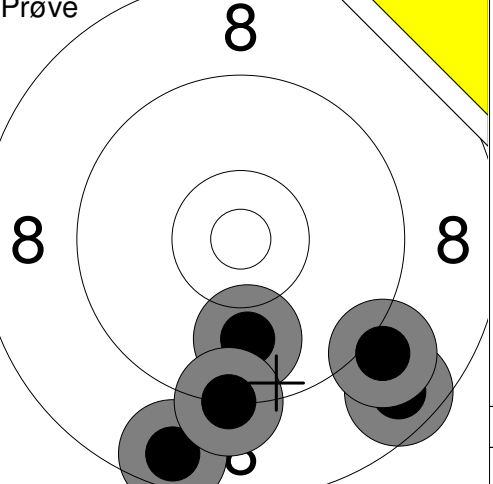
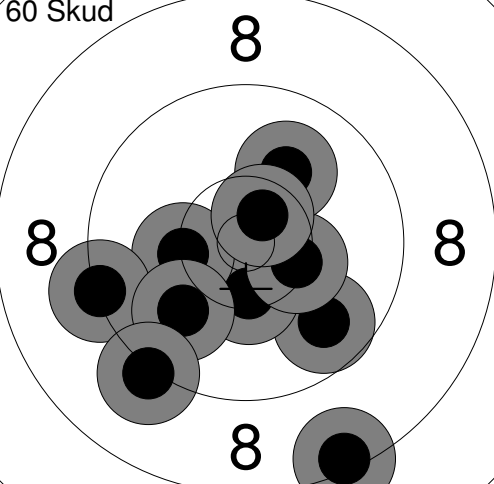
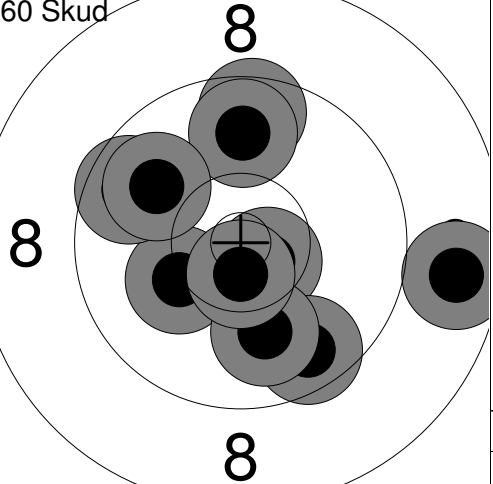
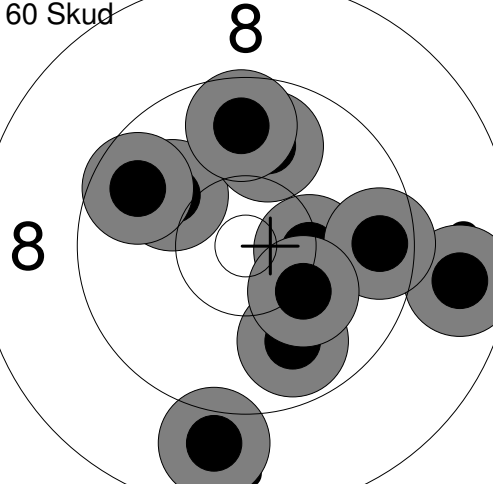
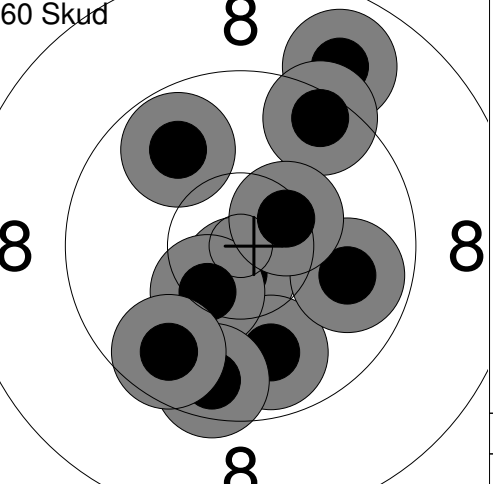
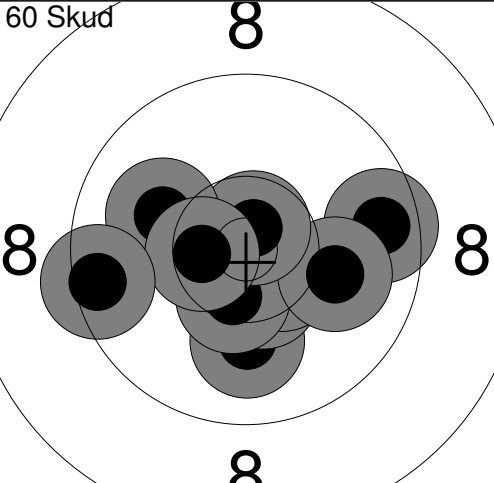
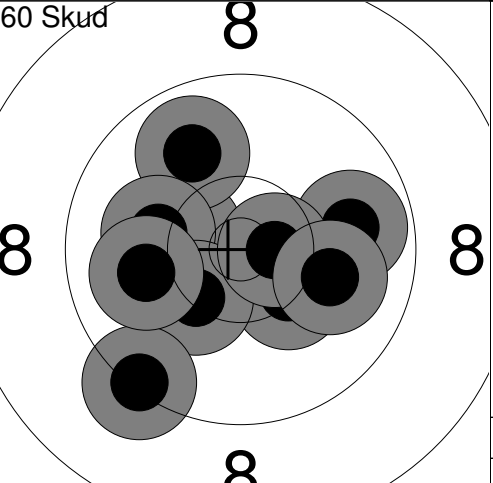
Prøve		Prøve	
	1: 9.9 ↓ 2: 8.2 ← 3: 7.4 ↓ 4: 10.3 ← 5: 8.4 ↓ 6: 8.4 ↗ 7: 10.0 ← 8: 9.5 ↓ 9: 8.6 ↓ 10: 8.2 ↓		11: *10.7 ↗ 12: 8.3 ↓ 13: 9.7 ↑ 14: *10.6 ↓ 15: 8.1 ↓ 16: 9.0 ↑ 17: 8.9 ↗
Serie 85.0		Serie 62.0	
Total 0.0		Total 0.0	
40 Skud 	1: *10.5 ← 2: 9.3 ↓ 3: 10.3 → 4: 10.0 ↗ 5: 9.6 → 6: 9.9 ← 7: 9.6 ↓ 8: 8.9 ← 9: 8.7 ↑ 10: 9.8 ↑	40 Skud 	11: 9.9 ↖ 12: 9.0 ↓ 13: 10.0 ↑ 14: 9.8 ↑ 15: 10.1 ↖ 16: 8.7 ↑ 17: 8.3 ↑ 18: 9.9 ← 19: 10.3 ← 20: 9.7 ↓
Serie 91.0		Serie 91.0	
Total 91.0		Total 182.0	
40 Skud 	21: 8.2 ↑ 22: 9.1 ↗ 23: 9.6 ↗ 24: 9.0 ← 25: 8.3 ← 26: 9.3 ← 27: *10.5 ↖ 28: 7.9 ↓ 29: 7.8 ← 30: 9.2 ↓	40 Skud 	31: 9.4 ↓ 32: 10.1 ← 33: 9.6 ↗ 34: 10.3 → 35: 9.7 ← 36: 7.9 ↓ 37: 9.1 ↑ 38: 10.1 ↖ 39: 9.9 ↓ 40: 10.2 ←
Serie 85.0		Serie 92.0	
Total 267.0		Total 359.0	

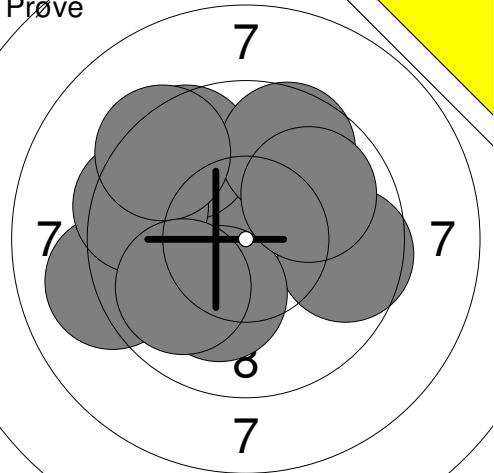
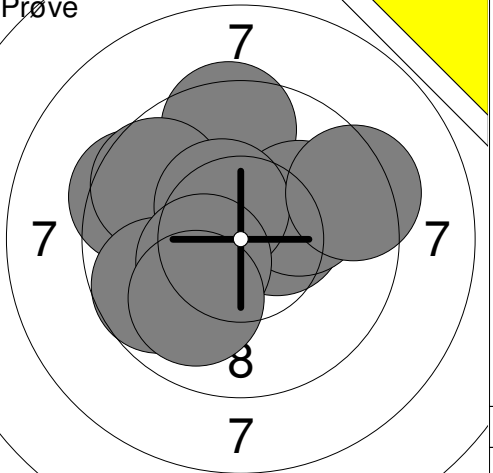
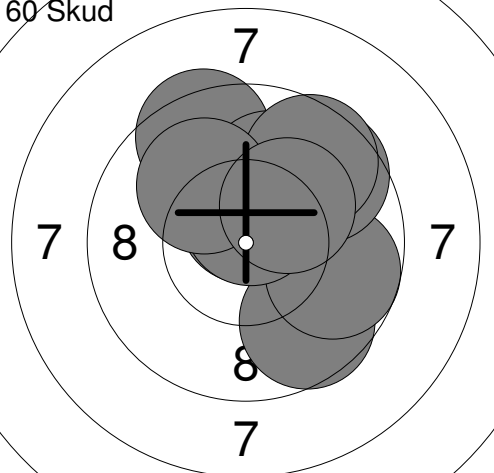
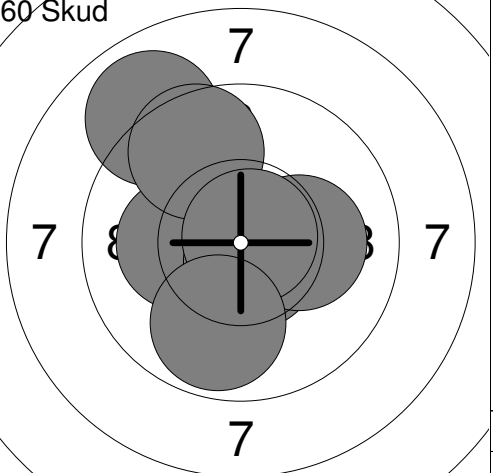
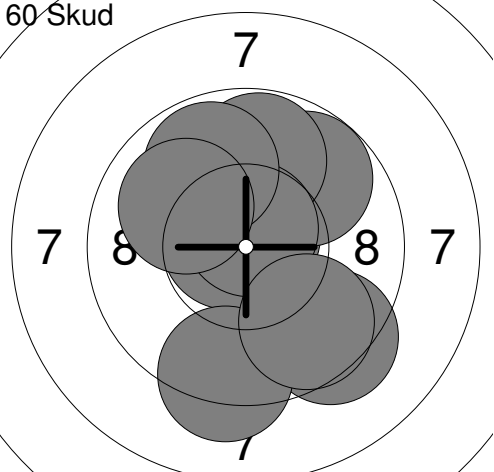
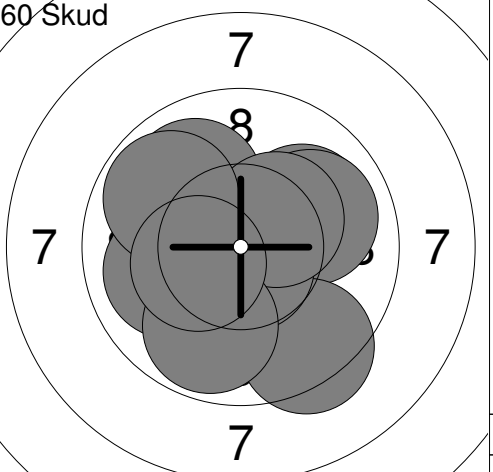
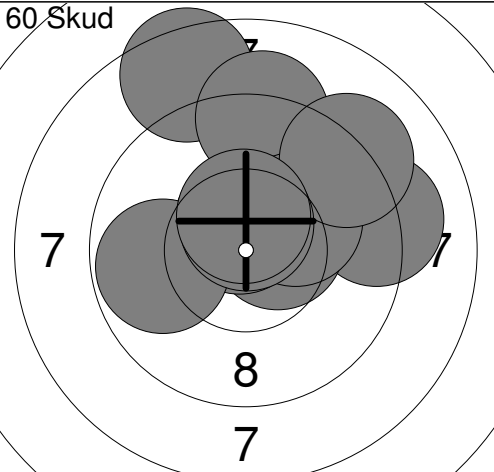
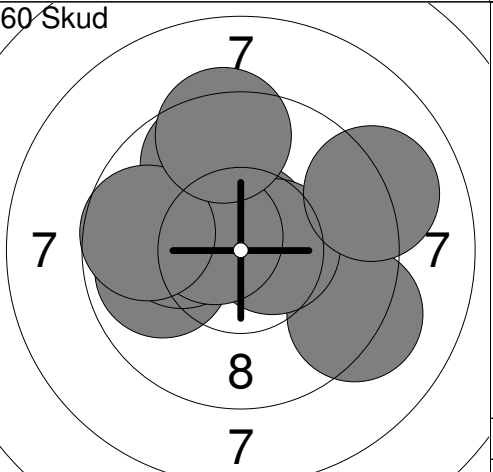
<p>Prøve</p> 	<table border="1" style="width:100%; border-collapse: collapse;"> <tr><td>1:</td><td>8.8</td><td>↗</td></tr> <tr><td>2:</td><td>*10.8</td><td>↓</td></tr> <tr><td>3:</td><td>9.6</td><td>↗</td></tr> <tr><td>4:</td><td>9.9</td><td>↗</td></tr> <tr><td>5:</td><td>9.4</td><td>↗</td></tr> <tr><td>6:</td><td>10.3</td><td>↓</td></tr> <tr><td>7:</td><td>9.7</td><td>↗</td></tr> <tr><td>8:</td><td>*10.4</td><td>↗</td></tr> <tr><td>9:</td><td>8.2</td><td>↙</td></tr> <tr><td>10:</td><td>9.9</td><td>↗</td></tr> <tr><td colspan="2">Serie</td><td>91.0</td></tr> <tr><td colspan="2">Total</td><td>0.0</td></tr> </table>	1:	8.8	↗	2:	*10.8	↓	3:	9.6	↗	4:	9.9	↗	5:	9.4	↗	6:	10.3	↓	7:	9.7	↗	8:	*10.4	↗	9:	8.2	↙	10:	9.9	↗	Serie		91.0	Total		0.0	<p>Prøve</p> 	<table border="1" style="width:100%; border-collapse: collapse;"> <tr><td>11:</td><td>8.6</td><td>↘</td></tr> <tr><td>12:</td><td>9.9</td><td>↓</td></tr> <tr><td>13:</td><td>9.0</td><td>↘</td></tr> <tr><td>14:</td><td>8.6</td><td>↓</td></tr> <tr><td>15:</td><td>9.2</td><td>↓</td></tr> <tr><td colspan="2">Serie</td><td>43.0</td></tr> <tr><td colspan="2">Total</td><td>0.0</td></tr> </table>	11:	8.6	↘	12:	9.9	↓	13:	9.0	↘	14:	8.6	↓	15:	9.2	↓	Serie		43.0	Total		0.0															
1:	8.8	↗																																																																									
2:	*10.8	↓																																																																									
3:	9.6	↗																																																																									
4:	9.9	↗																																																																									
5:	9.4	↗																																																																									
6:	10.3	↓																																																																									
7:	9.7	↗																																																																									
8:	*10.4	↗																																																																									
9:	8.2	↙																																																																									
10:	9.9	↗																																																																									
Serie		91.0																																																																									
Total		0.0																																																																									
11:	8.6	↘																																																																									
12:	9.9	↓																																																																									
13:	9.0	↘																																																																									
14:	8.6	↓																																																																									
15:	9.2	↓																																																																									
Serie		43.0																																																																									
Total		0.0																																																																									
<p>60 Skud</p> 	<table border="1" style="width:100%; border-collapse: collapse;"> <tr><td>1:</td><td>9.7</td><td>↘</td></tr> <tr><td>2:</td><td>*10.4</td><td>↓</td></tr> <tr><td>3:</td><td>10.3</td><td>←</td></tr> <tr><td>4:</td><td>*10.4</td><td>→</td></tr> <tr><td>5:</td><td>10.1</td><td>↗</td></tr> <tr><td>6:</td><td>9.3</td><td>←</td></tr> <tr><td>7:</td><td>9.9</td><td>↙</td></tr> <tr><td>8:</td><td>9.2</td><td>↙</td></tr> <tr><td>9:</td><td>8.4</td><td>↓</td></tr> <tr><td>10:</td><td>*10.6</td><td>↗</td></tr> <tr><td colspan="2">Serie</td><td>94.0</td></tr> <tr><td colspan="2">Total</td><td>94.0</td></tr> </table>	1:	9.7	↘	2:	*10.4	↓	3:	10.3	←	4:	*10.4	→	5:	10.1	↗	6:	9.3	←	7:	9.9	↙	8:	9.2	↙	9:	8.4	↓	10:	*10.6	↗	Serie		94.0	Total		94.0	<p>60 Skud</p> 	<table border="1" style="width:100%; border-collapse: collapse;"> <tr><td>11:</td><td>*10.6</td><td>↘</td></tr> <tr><td>12:</td><td>9.6</td><td>↑</td></tr> <tr><td>13:</td><td>9.6</td><td>↘</td></tr> <tr><td>14:</td><td>10.2</td><td>↙</td></tr> <tr><td>15:</td><td>9.8</td><td>↑</td></tr> <tr><td>16:</td><td>9.7</td><td>↖</td></tr> <tr><td>17:</td><td>10.0</td><td>↓</td></tr> <tr><td>18:</td><td>*10.6</td><td>↓</td></tr> <tr><td>19:</td><td>8.7</td><td>→</td></tr> <tr><td>20:</td><td>9.9</td><td>↖</td></tr> <tr><td colspan="2">Serie</td><td>93.0</td></tr> <tr><td colspan="2">Total</td><td>187.0</td></tr> </table>	11:	*10.6	↘	12:	9.6	↑	13:	9.6	↘	14:	10.2	↙	15:	9.8	↑	16:	9.7	↖	17:	10.0	↓	18:	*10.6	↓	19:	8.7	→	20:	9.9	↖	Serie		93.0	Total		187.0
1:	9.7	↘																																																																									
2:	*10.4	↓																																																																									
3:	10.3	←																																																																									
4:	*10.4	→																																																																									
5:	10.1	↗																																																																									
6:	9.3	←																																																																									
7:	9.9	↙																																																																									
8:	9.2	↙																																																																									
9:	8.4	↓																																																																									
10:	*10.6	↗																																																																									
Serie		94.0																																																																									
Total		94.0																																																																									
11:	*10.6	↘																																																																									
12:	9.6	↑																																																																									
13:	9.6	↘																																																																									
14:	10.2	↙																																																																									
15:	9.8	↑																																																																									
16:	9.7	↖																																																																									
17:	10.0	↓																																																																									
18:	*10.6	↓																																																																									
19:	8.7	→																																																																									
20:	9.9	↖																																																																									
Serie		93.0																																																																									
Total		187.0																																																																									
<p>60 Skud</p> 	<table border="1" style="width:100%; border-collapse: collapse;"> <tr><td>21:</td><td>8.7</td><td>→</td></tr> <tr><td>22:</td><td>10.3</td><td>→</td></tr> <tr><td>23:</td><td>10.0</td><td>↗</td></tr> <tr><td>24:</td><td>9.9</td><td>↑</td></tr> <tr><td>25:</td><td>9.9</td><td>↓</td></tr> <tr><td>26:</td><td>8.9</td><td>↓</td></tr> <tr><td>27:</td><td>9.7</td><td>↑</td></tr> <tr><td>28:</td><td>9.7</td><td>↗</td></tr> <tr><td>29:</td><td>9.6</td><td>→</td></tr> <tr><td>30:</td><td>10.2</td><td>↘</td></tr> <tr><td colspan="2">Serie</td><td>91.0</td></tr> <tr><td colspan="2">Total</td><td>278.0</td></tr> </table>	21:	8.7	→	22:	10.3	→	23:	10.0	↗	24:	9.9	↑	25:	9.9	↓	26:	8.9	↓	27:	9.7	↑	28:	9.7	↗	29:	9.6	→	30:	10.2	↘	Serie		91.0	Total		278.0	<p>60 Skud</p> 	<table border="1" style="width:100%; border-collapse: collapse;"> <tr><td>31:</td><td>*10.7</td><td>↓</td></tr> <tr><td>32:</td><td>9.9</td><td>↓</td></tr> <tr><td>33:</td><td>9.9</td><td>→</td></tr> <tr><td>34:</td><td>*10.4</td><td>↙</td></tr> <tr><td>35:</td><td>8.9</td><td>↗</td></tr> <tr><td>36:</td><td>9.6</td><td>↓</td></tr> <tr><td>37:</td><td>9.5</td><td>↗</td></tr> <tr><td>38:</td><td>9.7</td><td>↙</td></tr> <tr><td>39:</td><td>*10.4</td><td>↗</td></tr> <tr><td>40:</td><td>9.8</td><td>↖</td></tr> <tr><td colspan="2">Serie</td><td>92.0</td></tr> <tr><td colspan="2">Total</td><td>370.0</td></tr> </table>	31:	*10.7	↓	32:	9.9	↓	33:	9.9	→	34:	*10.4	↙	35:	8.9	↗	36:	9.6	↓	37:	9.5	↗	38:	9.7	↙	39:	*10.4	↗	40:	9.8	↖	Serie		92.0	Total		370.0
21:	8.7	→																																																																									
22:	10.3	→																																																																									
23:	10.0	↗																																																																									
24:	9.9	↑																																																																									
25:	9.9	↓																																																																									
26:	8.9	↓																																																																									
27:	9.7	↑																																																																									
28:	9.7	↗																																																																									
29:	9.6	→																																																																									
30:	10.2	↘																																																																									
Serie		91.0																																																																									
Total		278.0																																																																									
31:	*10.7	↓																																																																									
32:	9.9	↓																																																																									
33:	9.9	→																																																																									
34:	*10.4	↙																																																																									
35:	8.9	↗																																																																									
36:	9.6	↓																																																																									
37:	9.5	↗																																																																									
38:	9.7	↙																																																																									
39:	*10.4	↗																																																																									
40:	9.8	↖																																																																									
Serie		92.0																																																																									
Total		370.0																																																																									
<p>60 Skud</p> 	<table border="1" style="width:100%; border-collapse: collapse;"> <tr><td>41:</td><td>10.1</td><td>↓</td></tr> <tr><td>42:</td><td>*10.5</td><td>↓</td></tr> <tr><td>43:</td><td>*10.5</td><td>↓</td></tr> <tr><td>44:</td><td>9.6</td><td>→</td></tr> <tr><td>45:</td><td>*10.5</td><td>↓</td></tr> <tr><td>46:</td><td>10.0</td><td>→</td></tr> <tr><td>47:</td><td>*10.7</td><td>↗</td></tr> <tr><td>48:</td><td>10.1</td><td>↖</td></tr> <tr><td>49:</td><td>*10.5</td><td>←</td></tr> <tr><td>50:</td><td>9.5</td><td>←</td></tr> <tr><td colspan="2">Serie</td><td>98.0</td></tr> <tr><td colspan="2">Total</td><td>468.0</td></tr> </table>	41:	10.1	↓	42:	*10.5	↓	43:	*10.5	↓	44:	9.6	→	45:	*10.5	↓	46:	10.0	→	47:	*10.7	↗	48:	10.1	↖	49:	*10.5	←	50:	9.5	←	Serie		98.0	Total		468.0	<p>60 Skud</p> 	<table border="1" style="width:100%; border-collapse: collapse;"> <tr><td>51:</td><td>10.3</td><td>↘</td></tr> <tr><td>52:</td><td>*10.4</td><td>←</td></tr> <tr><td>53:</td><td>9.9</td><td>↗</td></tr> <tr><td>54:</td><td>10.1</td><td>←</td></tr> <tr><td>55:</td><td>10.3</td><td>↙</td></tr> <tr><td>56:</td><td>9.9</td><td>→</td></tr> <tr><td>57:</td><td>9.3</td><td>↙</td></tr> <tr><td>58:</td><td>*10.6</td><td>→</td></tr> <tr><td>59:</td><td>10.0</td><td>←</td></tr> <tr><td>60:</td><td>10.0</td><td>→</td></tr> <tr><td colspan="2">Serie</td><td>97.0</td></tr> <tr><td colspan="2">Total</td><td>565.0</td></tr> </table>	51:	10.3	↘	52:	*10.4	←	53:	9.9	↗	54:	10.1	←	55:	10.3	↙	56:	9.9	→	57:	9.3	↙	58:	*10.6	→	59:	10.0	←	60:	10.0	→	Serie		97.0	Total		565.0
41:	10.1	↓																																																																									
42:	*10.5	↓																																																																									
43:	*10.5	↓																																																																									
44:	9.6	→																																																																									
45:	*10.5	↓																																																																									
46:	10.0	→																																																																									
47:	*10.7	↗																																																																									
48:	10.1	↖																																																																									
49:	*10.5	←																																																																									
50:	9.5	←																																																																									
Serie		98.0																																																																									
Total		468.0																																																																									
51:	10.3	↘																																																																									
52:	*10.4	←																																																																									
53:	9.9	↗																																																																									
54:	10.1	←																																																																									
55:	10.3	↙																																																																									
56:	9.9	→																																																																									
57:	9.3	↙																																																																									
58:	*10.6	→																																																																									
59:	10.0	←																																																																									
60:	10.0	→																																																																									
Serie		97.0																																																																									
Total		565.0																																																																									

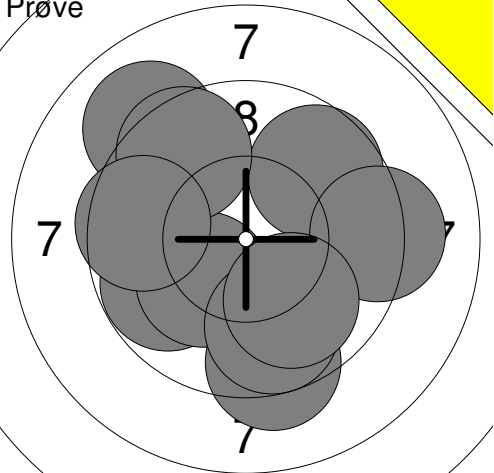
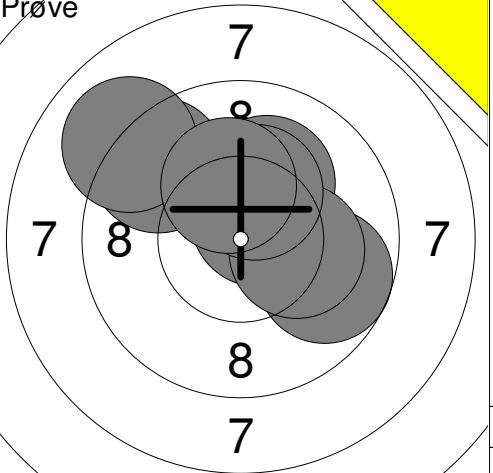
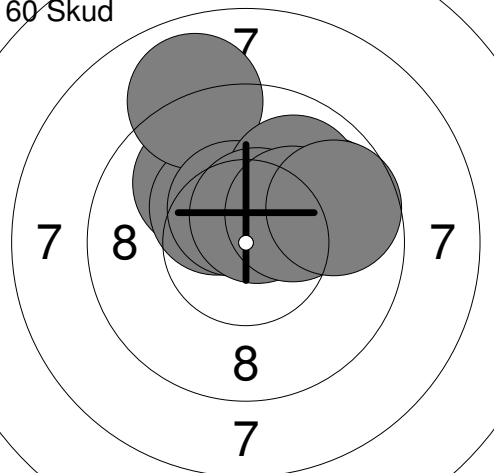
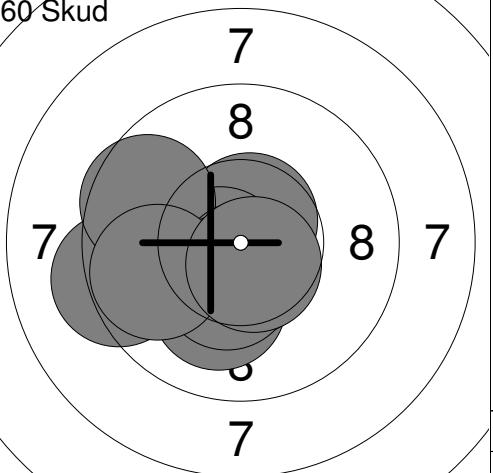
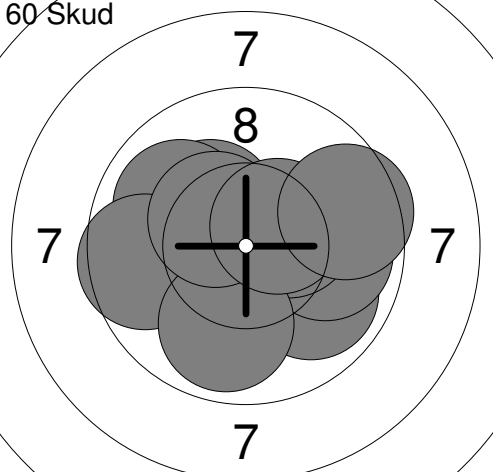
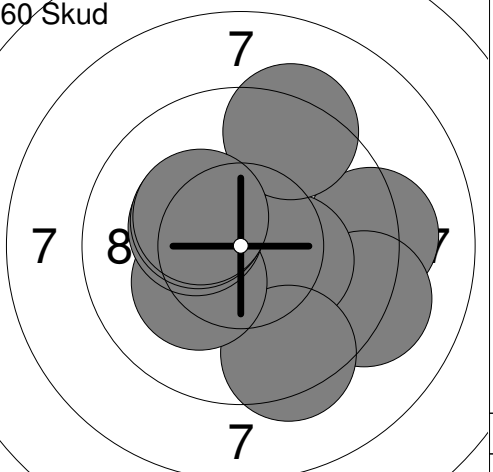
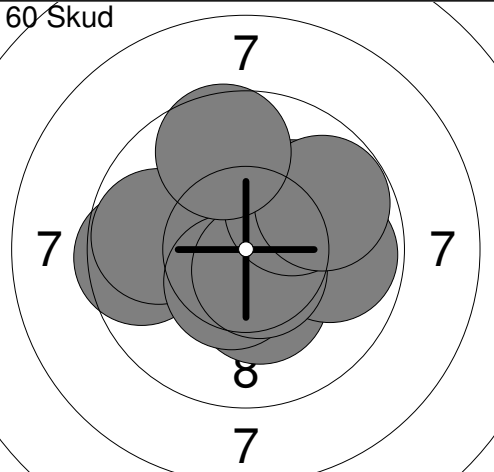
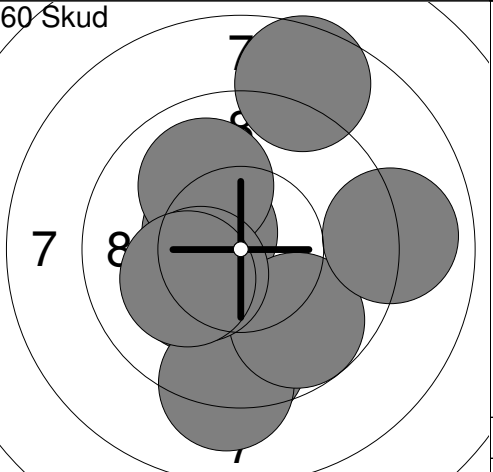
Hold	Skive	Karl H. Hamann			
4	4				
10m	Trehøje Skytteforening	H	R		
09.11.2012	10 meter luftstævne	Aalborg Skyttekreds			
Prøve		1: *10.3 ← 2: 9.1 ← 3: 9.6 ↗ 4: 9.5 ← 5: 9.6 → 6: 10.1 ↓ 7: 9.7 ↗ 8: 9.9 ↗ 9: 9.4 ↗ 10: 9.9 ← Serie 92.0 Total 0.0	Prøve		11: *10.4 → 12: 9.5 ← 13: 9.5 ↑ 14: 9.6 ↖ 15: 10.1 ↗ 16: *10.5 ↗ 17: 9.7 ← 18: *10.4 ← 19: 9.3 → 20: 10.0 ↓ Serie 95.0 Total 0.0
60 Skud		1: 9.4 ↗ 2: *10.6 ↑ 3: 9.6 ↓ 4: 9.7 → 5: 10.0 ↑ 6: 9.6 ↗ 7: 9.6 ↗ 8: *10.6 ↑ 9: 10.0 ↖ 10: *10.2 ↗ Serie 95.0 Total 95.0	60 Skud		11: *10.6 → 12: *10.9 ↑ 13: *10.8 ↓ 14: 9.0 ↗ 15: *10.2 ← 16: *10.7 ↓ 17: *10.2 → 18: 9.6 ↗ 19: *10.8 ↗ 20: 9.9 ↓ Serie 97.0 Total 192.0
60 Skud		21: 9.3 ↓ 22: *10.8 ↑ 23: 9.8 ↗ 24: *10.7 ← 25: 9.8 ↑ 26: *10.7 ↑ 27: 9.2 ↓ 28: 9.7 ↓ 29: 9.8 ↗ 30: 10.0 ↖ Serie 94.0 Total 286.0	60 Skud		31: 10.0 ↗ 32: 10.0 ↗ 33: 10.0 ← 34: 10.0 ↗ 35: 9.4 ↓ 36: *10.7 ↓ 37: *10.4 ↗ 38: 9.8 ↗ 39: 9.8 ↓ 40: *10.3 ← Serie 97.0 Total 383.0
60 Skud		41: 8.5 ↑ 42: 9.2 ↑ 43: 9.1 → 44: *10.5 → 45: *10.2 ↗ 46: *10.6 ↑ 47: 9.8 ← 48: 9.1 ↗ 49: *10.6 ↑ 50: *10.5 ↑ Serie 94.0 Total 477.0	60 Skud		51: *10.7 ↑ 52: 9.9 ← 53: 9.7 ↗ 54: 9.2 ↓ 55: *10.5 → 56: *10.2 ← 57: *10.6 ↖ 58: 9.7 ← 59: 9.4 ↑ 60: 9.1 → Serie 94.0 Total 571.0

Prøve	Prøve															
		<table style="width:100%; border-collapse: collapse;"> <tr><td>1: 9.0 ↗</td></tr> <tr><td>2: 9.7 ↗</td></tr> <tr><td>3: 9.8 ↖</td></tr> <tr><td>4: *10.2 ↙</td></tr> <tr><td>5: 9.3 ↘</td></tr> <tr><td>6: 9.8 ↙</td></tr> <tr><td>7: 9.6 ↗</td></tr> <tr><td>8: 9.6 ↖</td></tr> <tr><td>9: 9.2 →</td></tr> <tr><td>10: 9.9 ↘</td></tr> <tr><td colspan="2" style="border-top: 1px solid black;">Serie 91.0</td></tr> <tr><td colspan="2" style="border-top: 1px solid black;">Total 0.0</td></tr> </table>	1: 9.0 ↗	2: 9.7 ↗	3: 9.8 ↖	4: *10.2 ↙	5: 9.3 ↘	6: 9.8 ↙	7: 9.6 ↗	8: 9.6 ↖	9: 9.2 →	10: 9.9 ↘	Serie 91.0		Total 0.0	
1: 9.0 ↗																
2: 9.7 ↗																
3: 9.8 ↖																
4: *10.2 ↙																
5: 9.3 ↘																
6: 9.8 ↙																
7: 9.6 ↗																
8: 9.6 ↖																
9: 9.2 →																
10: 9.9 ↘																
Serie 91.0																
Total 0.0																
		<table style="width:100%; border-collapse: collapse;"> <tr><td>11: *10.6 ↗</td></tr> <tr><td>12: 9.7 →</td></tr> <tr><td>13: 9.5 ↗</td></tr> <tr><td>14: 10.1 ↗</td></tr> <tr><td>15: *10.2 →</td></tr> <tr><td>16: 9.0 ↗</td></tr> <tr><td>17: *10.3 ↗</td></tr> <tr><td>18: *10.2 ↗</td></tr> <tr><td colspan="2" style="border-top: 1px solid black;">Serie 77.0</td></tr> <tr><td colspan="2" style="border-top: 1px solid black;">Total 0.0</td></tr> </table>	11: *10.6 ↗	12: 9.7 →	13: 9.5 ↗	14: 10.1 ↗	15: *10.2 →	16: 9.0 ↗	17: *10.3 ↗	18: *10.2 ↗	Serie 77.0		Total 0.0			
11: *10.6 ↗																
12: 9.7 →																
13: 9.5 ↗																
14: 10.1 ↗																
15: *10.2 →																
16: 9.0 ↗																
17: *10.3 ↗																
18: *10.2 ↗																
Serie 77.0																
Total 0.0																
		<table style="width:100%; border-collapse: collapse;"> <tr><td>1: 10.0 ↗</td></tr> <tr><td>2: *10.4 ↗</td></tr> <tr><td>3: 9.0 ↗</td></tr> <tr><td>4: 10.0 ↗</td></tr> <tr><td>5: *10.5 ↗</td></tr> <tr><td>6: 9.8 →</td></tr> <tr><td>7: 9.9 ↗</td></tr> <tr><td>8: *10.6 ↗</td></tr> <tr><td>9: *10.2 ↗</td></tr> <tr><td>10: 9.7 →</td></tr> <tr><td colspan="2" style="border-top: 1px solid black;">Serie 96.0</td></tr> <tr><td colspan="2" style="border-top: 1px solid black;">Total 96.0</td></tr> </table>	1: 10.0 ↗	2: *10.4 ↗	3: 9.0 ↗	4: 10.0 ↗	5: *10.5 ↗	6: 9.8 →	7: 9.9 ↗	8: *10.6 ↗	9: *10.2 ↗	10: 9.7 →	Serie 96.0		Total 96.0	
1: 10.0 ↗																
2: *10.4 ↗																
3: 9.0 ↗																
4: 10.0 ↗																
5: *10.5 ↗																
6: 9.8 →																
7: 9.9 ↗																
8: *10.6 ↗																
9: *10.2 ↗																
10: 9.7 →																
Serie 96.0																
Total 96.0																
		<table style="width:100%; border-collapse: collapse;"> <tr><td>11: *10.6 ↗</td></tr> <tr><td>12: 9.7 ↖</td></tr> <tr><td>13: 10.1 ↘</td></tr> <tr><td>14: 9.3 ↖</td></tr> <tr><td>15: *10.6 ↖</td></tr> <tr><td>16: 9.6 ↖</td></tr> <tr><td>17: *10.6 ↘</td></tr> <tr><td>18: *10.4 ↘</td></tr> <tr><td>19: 9.8 ↖</td></tr> <tr><td>20: *10.6 ↘</td></tr> <tr><td colspan="2" style="border-top: 1px solid black;">Serie 96.0</td></tr> <tr><td colspan="2" style="border-top: 1px solid black;">Total 192.0</td></tr> </table>	11: *10.6 ↗	12: 9.7 ↖	13: 10.1 ↘	14: 9.3 ↖	15: *10.6 ↖	16: 9.6 ↖	17: *10.6 ↘	18: *10.4 ↘	19: 9.8 ↖	20: *10.6 ↘	Serie 96.0		Total 192.0	
11: *10.6 ↗																
12: 9.7 ↖																
13: 10.1 ↘																
14: 9.3 ↖																
15: *10.6 ↖																
16: 9.6 ↖																
17: *10.6 ↘																
18: *10.4 ↘																
19: 9.8 ↖																
20: *10.6 ↘																
Serie 96.0																
Total 192.0																
		<table style="width:100%; border-collapse: collapse;"> <tr><td>21: 9.9 ↘</td></tr> <tr><td>22: 9.9 →</td></tr> <tr><td>23: *10.4 →</td></tr> <tr><td>24: *10.3 ↗</td></tr> <tr><td>25: 9.9 ↗</td></tr> <tr><td>26: 9.6 ↖</td></tr> <tr><td>27: 9.9 ↘</td></tr> <tr><td>28: *10.4 ↗</td></tr> <tr><td>29: *10.5 ↗</td></tr> <tr><td>30: 9.6 →</td></tr> <tr><td colspan="2" style="border-top: 1px solid black;">Serie 94.0</td></tr> <tr><td colspan="2" style="border-top: 1px solid black;">Total 286.0</td></tr> </table>	21: 9.9 ↘	22: 9.9 →	23: *10.4 →	24: *10.3 ↗	25: 9.9 ↗	26: 9.6 ↖	27: 9.9 ↘	28: *10.4 ↗	29: *10.5 ↗	30: 9.6 →	Serie 94.0		Total 286.0	
21: 9.9 ↘																
22: 9.9 →																
23: *10.4 →																
24: *10.3 ↗																
25: 9.9 ↗																
26: 9.6 ↖																
27: 9.9 ↘																
28: *10.4 ↗																
29: *10.5 ↗																
30: 9.6 →																
Serie 94.0																
Total 286.0																
		<table style="width:100%; border-collapse: collapse;"> <tr><td>31: 9.2 →</td></tr> <tr><td>32: *10.8 ↖</td></tr> <tr><td>33: 9.2 →</td></tr> <tr><td>34: *10.3 →</td></tr> <tr><td>35: 9.4 ↘</td></tr> <tr><td>36: 9.3 ↗</td></tr> <tr><td>37: *10.2 ↖</td></tr> <tr><td>38: *10.3 ↖</td></tr> <tr><td>39: *10.3 ↖</td></tr> <tr><td>40: *10.3 ↗</td></tr> <tr><td colspan="2" style="border-top: 1px solid black;">Serie 96.0</td></tr> <tr><td colspan="2" style="border-top: 1px solid black;">Total 382.0</td></tr> </table>	31: 9.2 →	32: *10.8 ↖	33: 9.2 →	34: *10.3 →	35: 9.4 ↘	36: 9.3 ↗	37: *10.2 ↖	38: *10.3 ↖	39: *10.3 ↖	40: *10.3 ↗	Serie 96.0		Total 382.0	
31: 9.2 →																
32: *10.8 ↖																
33: 9.2 →																
34: *10.3 →																
35: 9.4 ↘																
36: 9.3 ↗																
37: *10.2 ↖																
38: *10.3 ↖																
39: *10.3 ↖																
40: *10.3 ↗																
Serie 96.0																
Total 382.0																
		<table style="width:100%; border-collapse: collapse;"> <tr><td>41: *10.2 ↖</td></tr> <tr><td>42: *10.3 ↘</td></tr> <tr><td>43: 9.8 →</td></tr> <tr><td>44: 9.6 ↖</td></tr> <tr><td>45: 9.8 ↖</td></tr> <tr><td>46: *10.5 ↘</td></tr> <tr><td>47: *10.6 ↘</td></tr> <tr><td>48: 10.1 ↗</td></tr> <tr><td>49: 9.8 ↗</td></tr> <tr><td>50: 9.6 ↗</td></tr> <tr><td colspan="2" style="border-top: 1px solid black;">Serie 95.0</td></tr> <tr><td colspan="2" style="border-top: 1px solid black;">Total 477.0</td></tr> </table>	41: *10.2 ↖	42: *10.3 ↘	43: 9.8 →	44: 9.6 ↖	45: 9.8 ↖	46: *10.5 ↘	47: *10.6 ↘	48: 10.1 ↗	49: 9.8 ↗	50: 9.6 ↗	Serie 95.0		Total 477.0	
41: *10.2 ↖																
42: *10.3 ↘																
43: 9.8 →																
44: 9.6 ↖																
45: 9.8 ↖																
46: *10.5 ↘																
47: *10.6 ↘																
48: 10.1 ↗																
49: 9.8 ↗																
50: 9.6 ↗																
Serie 95.0																
Total 477.0																
		<table style="width:100%; border-collapse: collapse;"> <tr><td>51: *10.2 ↘</td></tr> <tr><td>52: 9.5 ↘</td></tr> <tr><td>53: *10.5 ↖</td></tr> <tr><td>54: 9.2 ↘</td></tr> <tr><td>55: 9.8 ↘</td></tr> <tr><td>56: 10.0 ↗</td></tr> <tr><td>57: *10.3 ↖</td></tr> <tr><td>58: 8.6 ↗</td></tr> <tr><td>59: 9.0 →</td></tr> <tr><td>60: *10.2 ↖</td></tr> <tr><td colspan="2" style="border-top: 1px solid black;">Serie 94.0</td></tr> <tr><td colspan="2" style="border-top: 1px solid black;">Total 571.0</td></tr> </table>	51: *10.2 ↘	52: 9.5 ↘	53: *10.5 ↖	54: 9.2 ↘	55: 9.8 ↘	56: 10.0 ↗	57: *10.3 ↖	58: 8.6 ↗	59: 9.0 →	60: *10.2 ↖	Serie 94.0		Total 571.0	
51: *10.2 ↘																
52: 9.5 ↘																
53: *10.5 ↖																
54: 9.2 ↘																
55: 9.8 ↘																
56: 10.0 ↗																
57: *10.3 ↖																
58: 8.6 ↗																
59: 9.0 →																
60: *10.2 ↖																
Serie 94.0																
Total 571.0																

Hold	Skive	Michael Chrisensen			
4	6	Trehøje Skytteforening		H	R
09.11.2012		10 meter luftstævne		Aalborg Skyttekreds	
Prøve 	1: 9.9 ↘	Prøve 	11: 9.7 ↘	Serie 93.0 Total 0.0	11: 9.7 ↘
	2: 8.4 ↘		12: 10.1 →		12: 10.1 →
	3: 10.1 →		13: 9.4 →		13: 9.4 →
	4: *10.2 ←		14: *10.4 ↘		14: *10.4 ↘
	5: 10.0 ←		15: 8.7 ↘		15: 8.7 ↘
	6: 8.4 ↘		16: *10.2 ↘		16: *10.2 ↘
	7: 9.3 ↘		17: *10.2 →		17: *10.2 →
	8: *10.6 ↗		18: 9.9 ↗		18: 9.9 ↗
	9: 9.1 ↘		19: 9.8 ↘		19: 9.8 ↘
	10: 10.0 ↘		20: *10.3 ←		20: *10.3 ←
Prøve 	21: 9.6 ←	60 Skud 	1: 10.1 ↗	Serie 67.0 Total 0.0	1: 10.1 ↗
	22: *10.8 ↗		2: *10.4 ↘		2: *10.4 ↘
	23: 9.9 ↘		3: *10.7 ↗		3: *10.7 ↗
	24: *10.3 ↗		4: *10.4 ↗		4: *10.4 ↗
	25: *10.7 ↘		5: *10.4 ←		5: *10.4 ←
	26: 9.7 →		6: *10.6 ↘		6: *10.6 ↘
	27: *10.5 ↘		7: 9.4 ↗		7: 9.4 ↗
			8: *10.4 →		8: *10.4 →
			9: *10.6 ↗		9: *10.6 ↗
			10: 9.9 ↗		10: 9.9 ↗
60 Skud 	11: 9.9 ↗	60 Skud 	21: *10.7 ↘	Serie 95.0 Total 193.0	21: *10.7 ↘
	12: 10.1 →		22: *10.7 ↗		22: *10.7 ↗
	13: *10.8 ↘		23: 9.7 ←		23: 9.7 ←
	14: *10.5 ↗		24: 9.6 ←		24: 9.6 ←
	15: 9.6 ↗		25: *10.5 ↗		25: *10.5 ↗
	16: *10.6 ↗		26: *10.3 ↘		26: *10.3 ↘
	17: 9.7 ↗		27: *10.9 ↗		27: *10.9 ↗
	18: 9.9 ↘		28: *10.2 ↗		28: *10.2 ↗
	19: 9.9 ↘		29: 9.7 ←		29: 9.7 ←
	20: *10.5 ↗		30: *10.5 ↗		30: *10.5 ↗
60 Skud 	31: 9.8 ←	60 Skud 	41: *10.6 ↗	Serie 95.0 Total 385.0	41: *10.6 ↗
	32: 10.0 ↘		42: 9.4 →		42: 9.4 →
	33: *10.5 ↗		43: 9.2 ↗		43: 9.2 ↗
	34: 9.8 ↘		44: 9.9 ↘		44: 9.9 ↘
	35: 8.8 ↘		45: 9.6 ↘		45: 9.6 ↘
	36: *10.6 ←		46: 9.9 ↗		46: 9.9 ↗
	37: *10.6 →		47: *10.8 ↗		47: *10.8 ↗
	38: 9.8 ←		48: *10.4 ←		48: *10.4 ←
	39: 10.0 →		49: *10.7 ←		49: *10.7 ←
	40: *10.6 ←		50: *10.2 ↗		50: *10.2 ↗
60 Skud 	51: 9.6 ←			Serie 98.0 Total 578.0	
	52: 10.1 ↘				
	53: 10.1 ↗				
	54: 10.0 ←				
	55: 9.8 ↘				
	56: *10.7 ←				
	57: *10.2 ↘				
	58: *10.8 ↘				
	59: *10.7 ↗				
	60: 10.0 →				

Hold	Skive	Morten Flecks	
4	7		
10m	DSB/ASF	H	R
09.11.2012	10 meter luftstævne	Aalborg Skyttekreds	
Prøve		2: 9.9 ← 3: 9.8 ↗ 4: *10.4 ↗ 5: 8.5 ↖ 6: *10.3 ↘ 7: *10.3 → 8: *10.4 ↑ 9: *10.3 ↗ 10: 9.1 ← Serie 85.0 Total 0.0	Prøve
			11: *10.2 ↓ 12: 9.8 ↑ 13: *10.6 ← 14: *10.6 ← 15: *10.3 ← 16: 9.4 ↖ 17: *10.4 → 18: *10.7 ← Serie 78.0 Total 0.0
60 Skud		1: *10.2 ↗ 2: *10.9 ↖ 3: *10.8 → 4: 10.1 ← 5: 9.7 ↗ 6: *10.6 ↖ 7: 9.9 ← 8: 10.1 ↑ 9: 9.7 ↗ 10: 10.1 ↑ Serie 97.0 Total 97.0	60 Skud
			11: *10.3 ↖ 12: *10.3 ↗ 13: *10.5 ↓ 14: *10.4 ↑ 15: 9.5 ← 16: 9.5 ↖ 17: *10.9 ↓ 18: *10.4 ↑ 19: 9.3 ← 20: 9.8 ↑ Serie 96.0 Total 193.0
60 Skud		21: *10.6 → 22: 10.0 ↗ 23: 9.2 ↗ 24: 9.5 ← 25: *10.4 ↗ 26: *10.3 ↖ 27: *10.8 ↓ 28: *10.3 ↗ 29: *10.2 ← 30: *10.2 ↖ Serie 98.0 Total 291.0	60 Skud
			31: *10.3 ↖ 32: 9.6 ← 33: *10.5 ← 34: *10.3 ↓ 35: 9.7 ↗ 36: *10.4 → 37: *10.5 ← 38: 9.8 → 39: 10.0 ↑ 40: *10.4 ↑ Serie 97.0 Total 388.0
60 Skud		41: 10.1 → 42: *10.2 ↑ 43: *10.6 ↘ 44: *10.4 ↗ 45: *10.4 ↖ 46: 9.9 ↖ 47: *10.6 ↗ 48: 10.1 ↘ 49: *10.2 ↗ 50: 10.1 ↑ Serie 99.0 Total 487.0	60 Skud
			51: *10.6 ↗ 52: *10.2 ↓ 53: 9.6 ↑ 54: *10.2 ↖ 55: *10.4 ↓ 56: 9.7 ↑ 57: 10.1 ↗ 58: *10.8 ↑ 59: *10.5 ↖ 60: *10.4 ← Serie 98.0 Total 585.0

Hold	Skive	Lars Ørum	
4	8		
10m	Aalborg Skyttekreds	H	R
09.11.2012	10 meter luftstævne	Aalborg Skyttekreds	
Prøve		Prøve	
60 Skud		60 Skud	
60 Skud		60 Skud	
60 Skud		60 Skud	
Serie 98.0		Serie 39.0	
Total 0.0		Total 0.0	
Serie 98.0		Serie 99.0	
Total 98.0		Total 197.0	
Serie 99.0		Serie 99.0	
Total 296.0		Total 395.0	
Serie 98.0		Serie 100.0	
Total 493.0		Total 593.0	

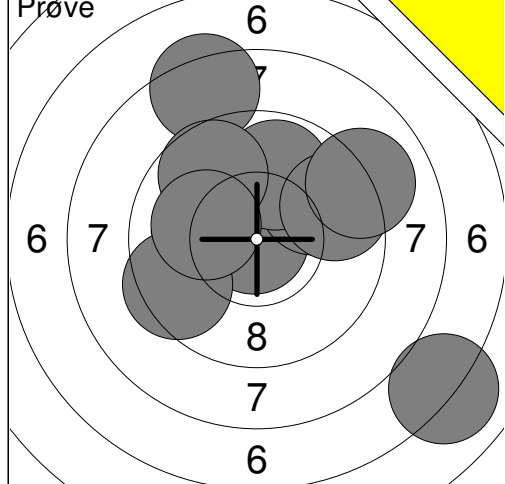

1:	*10.9	←
2:	9.5	↙
3:	9.8	↗
4:	7.0	↘
5:	9.9	↑
6:	9.6	→
7:	8.3	↗
8:	9.7	↗
9:	10.1	↖
10:	9.0	↗
Serie		89.0
Total		0.0

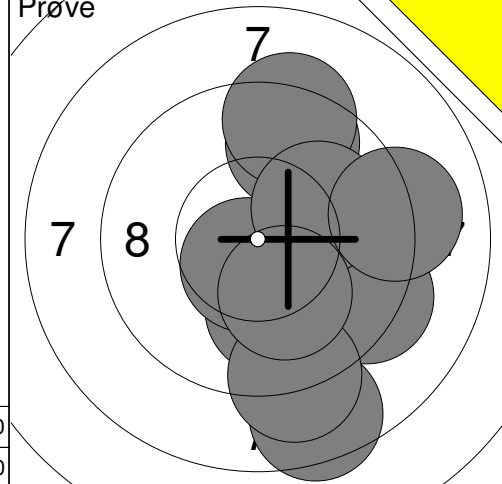

11:	9.3	↘
12:	8.5	↘
13:	10.0	↘
14:	9.1	↘
15:	9.6	↑
16:	*10.6	↘
17:	9.3	↑
18:	10.0	↗
19:	9.1	→
20:	10.1	↘
Serie		93.0
Total		0.0

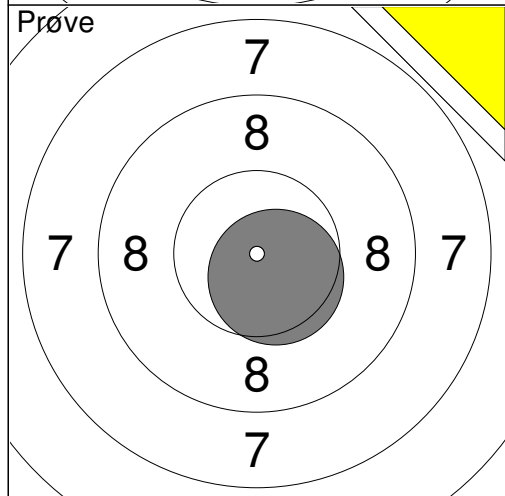

21:	*10.6	↘
Serie		10.0
Total		0.0

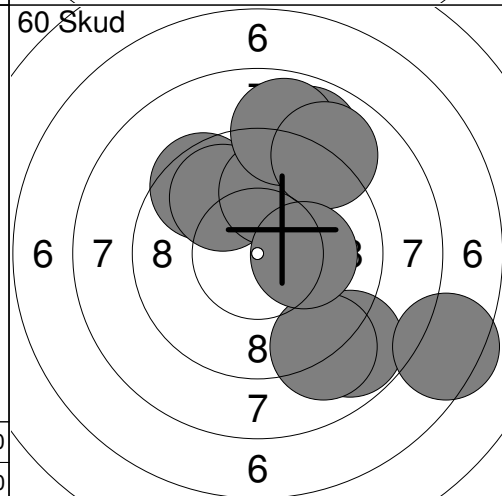

1:	8.8	↘
2:	9.0	↘
3:	9.5	↗
4:	9.8	↗
5:	9.9	↑
6:	8.9	↑
7:	8.9	↑
8:	7.4	↘
9:	9.0	↗
10:	*10.2	→
Serie		86.0
Total		86.0

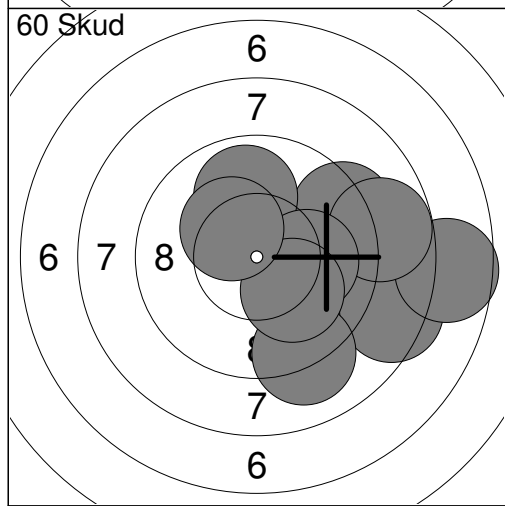

11:	9.3	↗
12:	9.2	→
13:	8.4	↘
14:	9.1	↘
15:	7.7	→
16:	8.8	→
17:	9.9	↑
18:	10.1	→
19:	10.1	↘
20:	*10.3	↗
Serie		89.0
Total		175.0

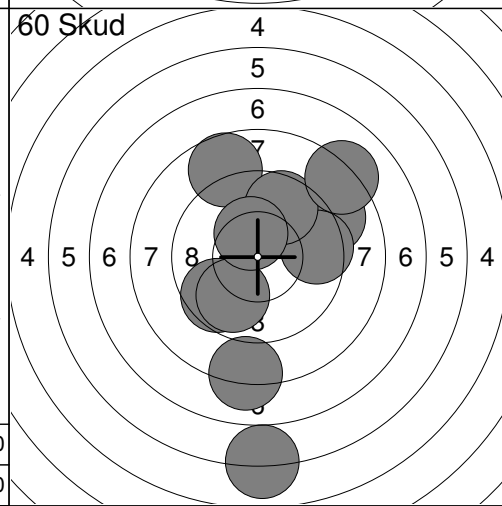

21:	9.6	↙
22:	9.8	↙
23:	9.0	↗
24:	9.5	→
25:	6.0	↘
26:	8.7	↖
27:	9.6	↗
28:	8.1	↘
29:	8.1	↗
30:	*10.4	↑
Serie		85.0
Total		260.0

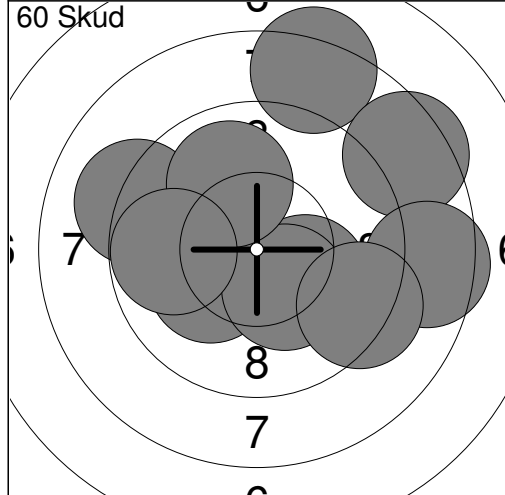

31:	8.3	↑
32:	*10.2	↘
33:	*10.2	↙
34:	9.1	↖
35:	8.4	↗
36:	*10.3	↘
37:	10.0	↗
38:	9.8	←
39:	8.5	→
40:	9.3	↘
Serie		91.0
Total		351.0

Prøve 	1: 9.1 ↘ 2: 8.8 ↘ 3: 9.5 ↘ 4: *10.7 ↘ 5: 9.7 ↗ 6: 9.5 ← 7: 9.9 ↗ 8: *10.7 ↘ 9: 9.9 ← 10: *10.6 → Serie 92.0 Total 0.0	Prøve 	11: *10.2 ↗ 12: 9.9 ← 13: 9.8 → 14: *10.7 ↘ 15: *10.4 ↗ Serie 48.0 Total 0.0
60 Skud 	1: 9.6 → 2: *10.4 ↘ 3: 9.9 → 4: 9.9 ↗ 5: 10.0 ↗ 6: *10.7 ↘ 7: *10.5 ↘ 8: *10.4 ↘ 9: *10.5 ↗ 10: 10.0 ← Serie 97.0 Total 97.0	60 Skud 	11: 9.5 ↗ 12: *10.7 ← 13: *10.2 ↘ 14: *10.5 ↘ 15: *10.7 ↘ 16: *10.6 → 17: *10.4 → 18: *10.9 → 19: *10.6 ↑ 20: *10.6 ↗ Serie 99.0 Total 196.0
60 Skud 	21: *10.4 ← 22: *10.6 ← 23: 9.6 → 24: 10.1 ↗ 25: *10.6 ↗ 26: 10.0 ↘ 27: *10.3 ↗ 28: *10.7 ↑ 29: 9.9 ↗ 30: *10.3 → Serie 98.0 Total 294.0	60 Skud 	31: *10.5 ↗ 32: *10.2 ← 33: 9.4 ← 34: *10.2 ↑ 35: 10.0 ↗ 36: *10.4 ← 37: *10.8 → 38: *10.6 ↗ 39: *10.5 ↗ 40: *10.9 ↘ Serie 99.0 Total 393.0
60 Skud 	41: *10.4 ↑ 42: *10.6 ← 43: *10.2 ↘ 44: *10.6 ↑ 45: 9.9 ↘ 46: *10.5 ← 47: *10.2 ← 48: 10.1 → 49: *10.3 ↗ 50: 10.1 → Serie 99.0 Total 492.0	60 Skud 	51: 9.9 ← 52: *10.3 ↗ 53: *10.2 ↘ 54: *10.7 ← 55: *10.2 ↘ 56: *10.2 ↘ 57: 9.5 → 58: 9.9 ↗ 59: 9.8 ↘ 60: *10.8 → Serie 96.0 Total 588.0

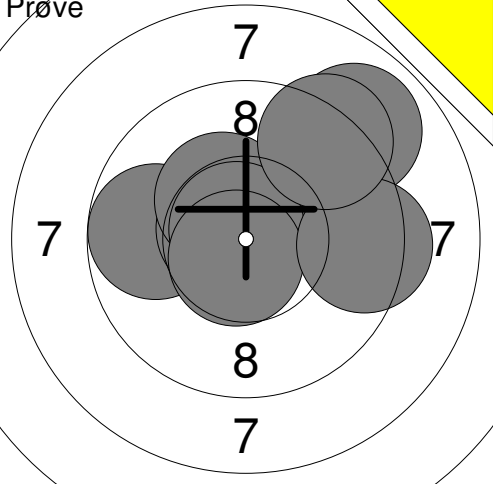
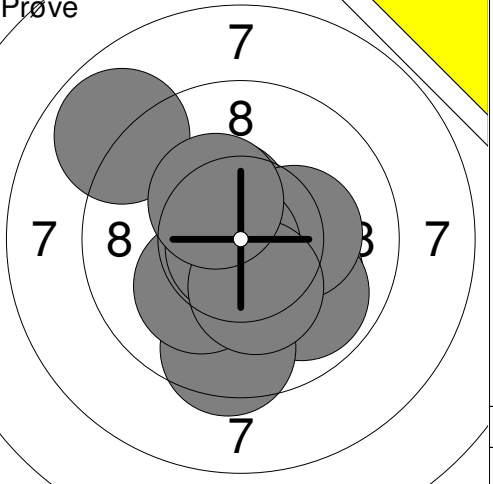
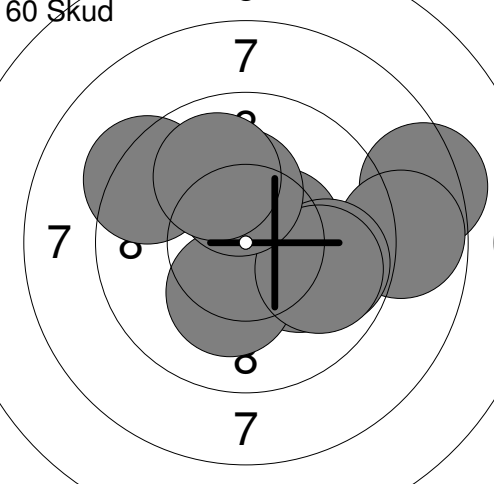
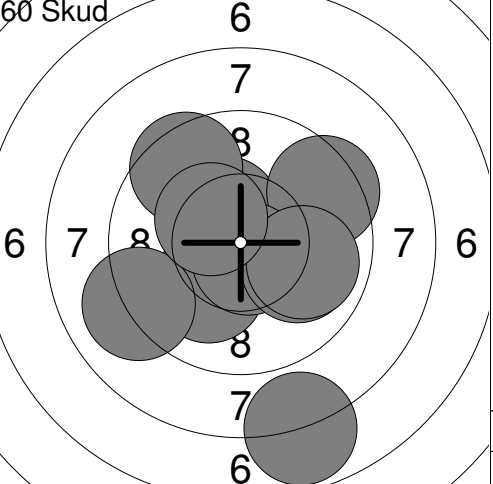
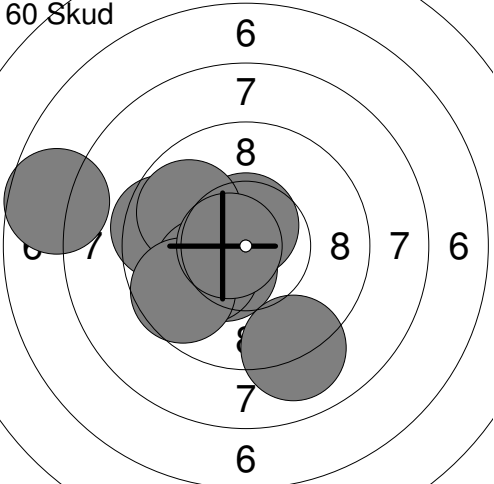
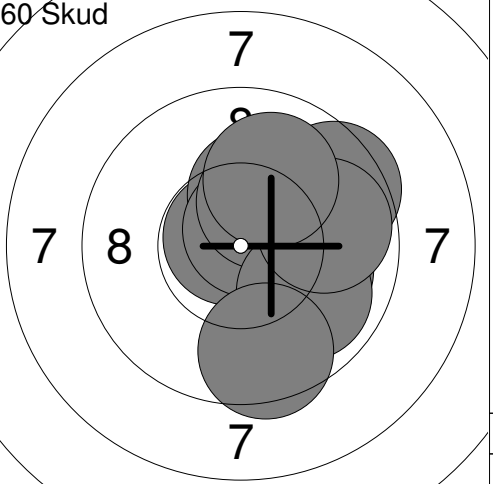
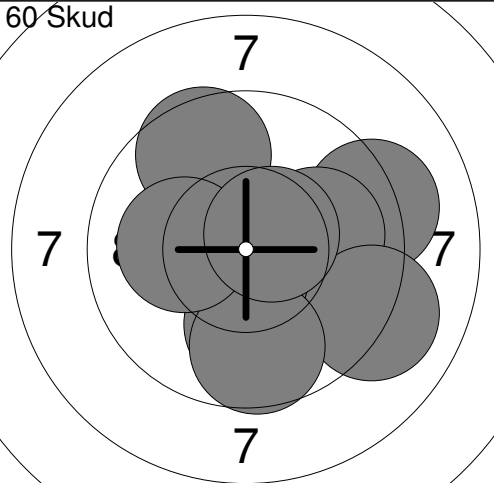
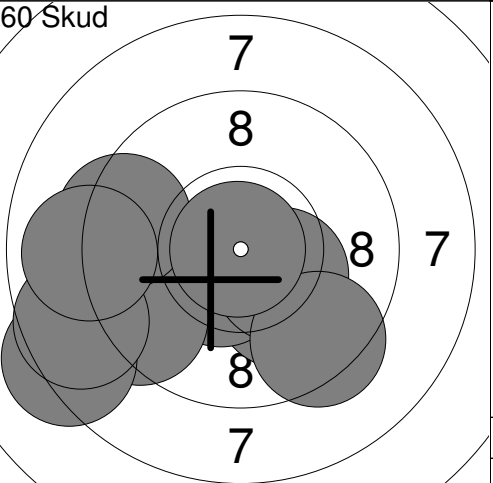
Prøve 	1: 9.8 ← 2: *10.6 ↖ 3: 9.7 ↗ 4: 9.9 → 5: 8.9 ↗ 6: *10.3 ↗ 7: *10.8 ↗ 8: *10.7 ↓ 9: 9.4 → 10: 9.3 ↗ Serie 93.0 Total 0.0	Prøve 	11: 10.1 → 12: 9.9 ↓ 13: 9.5 ↓ 14: *10.5 ↗ 15: 10.1 ↓ 16: *10.2 → 17: 8.9 ↗ 18: *10.8 ↓ 19: *10.3 ↓ 20: *10.3 ↗ Serie 96.0 Total 0.0
60 Skud 	1: 10.1 → 2: 8.4 → 3: *10.5 → 4: 8.8 → 5: *10.2 ↓ 6: 9.8 → 7: 9.9 → 8: 9.3 ↗ 9: *10.2 ↑ 10: 9.9 ↗ Serie 92.0 Total 92.0	60 Skud 	11: *10.4 ↗ 12: 10.1 ↓ 13: 9.5 ↗ 14: 9.4 ↗ 15: 9.1 ← 16: 7.8 ↓ 17: *10.7 ↓ 18: 10.0 → 19: 9.9 → 20: *10.4 ↗ Serie 93.0 Total 185.0
60 Skud 	21: 9.5 ← 22: *10.6 ↑ 23: 7.7 ← 24: *10.4 ↓ 25: *10.3 ← 26: 9.8 ↗ 27: *10.2 ← 28: 9.7 ← 29: *10.7 ← 30: 9.0 ↓ Serie 93.0 Total 278.0	60 Skud 	31: *10.8 ↗ 32: 10.0 → 33: *10.3 ↑ 34: *10.7 ↗ 35: 9.5 ↗ 36: *10.3 ↗ 37: 9.9 ↓ 38: 9.8 → 39: 10.0 ↗ 40: 9.5 ↓ Serie 96.0 Total 374.0
60 Skud 	41: *10.7 ↓ 42: 9.2 → 43: 10.0 → 44: 9.6 ↗ 45: *10.4 ↓ 46: 10.0 ↓ 47: 9.1 → 48: 9.7 ↓ 49: 10.1 ← 50: *10.6 ↗ Serie 96.0 Total 470.0	60 Skud 	51: 10.1 ↓ 52: *10.5 ↓ 53: 9.3 ← 54: 8.3 ← 55: *10.3 ↓ 56: 9.4 ← 57: 8.6 ← 58: 9.4 ↓ 59: *10.9 ← 60: 9.0 ← Serie 92.0 Total 562.0

Hold	Skive	Erik Skovmand													
4	12	Viborg Skytteforening		H	R										
09.11.2012		10 meter luftstævne		Aalborg Skyttekreds											
Prøve		1: *10.2 ↗	2: *10.5 ←	3: *10.5 →	4: 9.8 ←	5: *10.6 ↓	6: *10.4 ←	7: *10.3 ↑	8: 10.1 ↓	9: *10.7 →	10: *10.4 ↗	Serie	99.0	Total	0.0
Prøve		11: *10.4 ↗	12: *10.6 ↙	13: 10.0 ↓	14: 10.0 ↑	15: 9.7 →	16: *10.6 ↗	Serie	59.0	Total	0.0				
60 Skud		1: *10.7 ↗	2: *10.7 ←	3: 10.1 ←	4: *10.4 ↘	5: *10.3 →	6: 10.1 →	7: *10.4 ↓	8: *10.7 ↓	9: *10.4 ↑	10: *10.2 →	Serie	100.0	Total	100.0
60 Skud		11: *10.4 →	12: *10.6 ←	13: 10.1 ↖	14: 9.9 ↑	15: 9.9 ↑	16: 10.0 ↗	17: *10.4 ↓	18: *10.6 ↗	19: *10.7 ↗	20: *10.4 ↑	Serie	98.0	Total	198.0
60 Skud		21: *10.2 →	22: *10.6 ↗	23: 9.9 ↓	24: *10.4 ↑	25: *10.4 ↗	26: *10.4 ←	27: *10.6 ↓	28: *10.3 ↙	29: 10.1 ↑	30: 9.5 ↓	Serie	98.0	Total	296.0
60 Skud		31: 9.8 ↙	32: 10.0 ←	33: 9.7 →	34: 9.9 ↗	35: *10.4 ↗	36: 9.9 ←	37: 10.1 ←	38: *10.3 ↑	39: 10.1 ←	40: *10.3 ↙	Serie	96.0	Total	392.0
60 Skud		41: *10.5 ↗	42: *10.6 ↗	43: 10.0 ↓	44: *10.2 ↙	45: *10.3 ←	46: 9.5 ↗	47: 9.8 ↓	48: *10.6 ↓	49: 9.7 ↓	50: *10.2 ↓	Serie	97.0	Total	489.0
60 Skud		51: 9.4 ↙	52: *10.7 ↘	53: *10.4 ↑	54: *10.7 ↓	55: 9.4 ↓	56: *10.2 ↓	57: *10.5 ↙	58: *10.5 ↗	59: *10.7 →	60: *10.2 ↗	Serie	98.0	Total	587.0

<p>Prøve</p>	<p>1: 8.7 ↓ 2: 8.4 → 3: 8.5 → 4: *10.4 ↓ 5: 8.5 → 6: *10.4 ← 7: 10.3 ↗ 8: 9.0 → 9: 10.3 ↗ 10: 7.4 ↓</p> <p>Serie 88.0 Total 0.0</p>	<p>Prøve</p>	<p>11: 8.8 ↓ 12: 8.9 ↓ 13: 8.5 ↓ 14: *10.6 ← 15: 10.1 ↙ 16: 8.1 → 17: 7.7 ↓ 18: 9.3 → 19: 7.8 → 20: 9.1 →</p> <p>Serie 84.0 Total 0.0</p>
--------------	---	--------------	---

<p>40 Skud</p>	<p>1: 7.7 ↙ 2: 10.2 ↗ 3: 8.7 ↓ 4: 8.9 ↓ 5: 10.1 ↓ 6: 8.5 → 7: 8.2 ← 8: 9.0 ↑ 9: 8.3 ↓ 10: 10.2 ↗</p> <p>Serie 86.0 Total 86.0</p>	<p>40 Skud</p>	<p>11: *10.5 → 12: 9.8 ↓ 13: 9.0 ↓ 14: 8.7 ↖ 15: 8.6 → 16: *10.7 ↓ 17: 9.5 ↓ 18: 9.4 ↑ 19: 9.0 → 20: 9.4 →</p> <p>Serie 90.0 Total 176.0</p>
----------------	---	----------------	--

<p>40 Skud</p>	<p>21: 10.1 ↓ 22: 9.3 ↑ 23: 9.8 ↓ 24: 6.6 ↗ 25: 10.0 ↓ 26: 8.4 → 27: 9.6 ↗ 28: 10.2 ← 29: 9.6 ↓ 30: 9.7 ↓</p> <p>Serie 89.0 Total 265.0</p>	<p>40 Skud</p>	<p>31: 9.7 ↖ 32: 10.3 ↑ 33: *10.5 ↓ 34: *10.4 ↓ 35: 9.7 ↓ 36: 9.5 ↓ 37: 9.5 ↖ 38: 9.9 ↑ 39: 9.2 ← 40: 9.3 ↑</p> <p>Serie 93.0 Total 358.0</p>
----------------	---	----------------	---

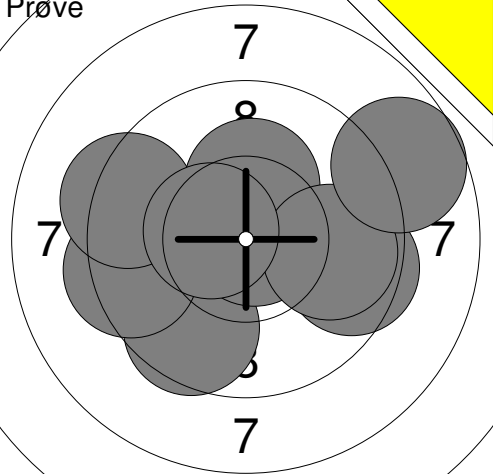
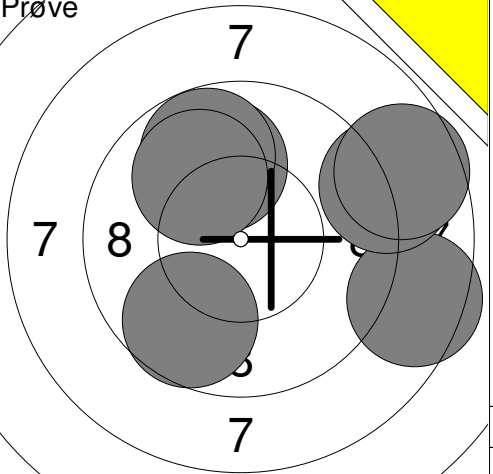
Prøve 	1: 9.6 ↘ 2: 9.4 ← 3: 9.3 ← 4: *10.8 ↑ 5: 9.5 → 6: *10.8 → 7: *10.2 ↑ 8: 9.8 → 9: 8.7 → 10: *10.5 ← <hr/> Serie 93.0 Total 0.0	Prøve 	11: 8.5 → 12: 8.9 → 13: 8.6 → 14: 9.9 ↑ 15: 9.7 ↘ 16: 9.8 ↑ 17: 10.0 ↗ <hr/> Serie 61.0 Total 0.0
--	--	--	---

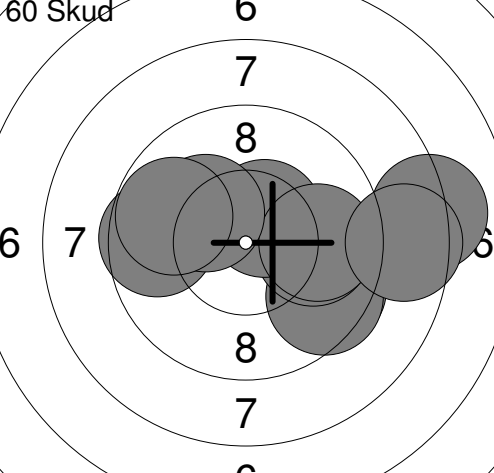
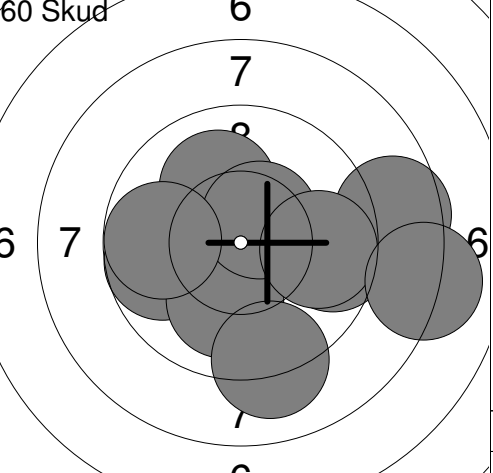
60 Skud 	1: 9.6 ← 2: 9.5 ↘ 3: 9.5 ↘ 4: 8.1 → 5: 9.9 → 6: *10.5 ↗ 7: 9.9 → 8: *10.2 ↗ 9: 8.5 → 10: 9.8 ← <hr/> Serie 90.0 Total 90.0	60 Skud 	11: 9.5 → 12: 9.7 ← 13: 10.0 ↘ 14: 10.1 ↗ 15: *10.5 ↗ 16: 8.6 → 17: 9.1 ↘ 18: 9.8 → 19: 8.1 → 20: 9.8 ← <hr/> Serie 91.0 Total 181.0
---	---	---	---

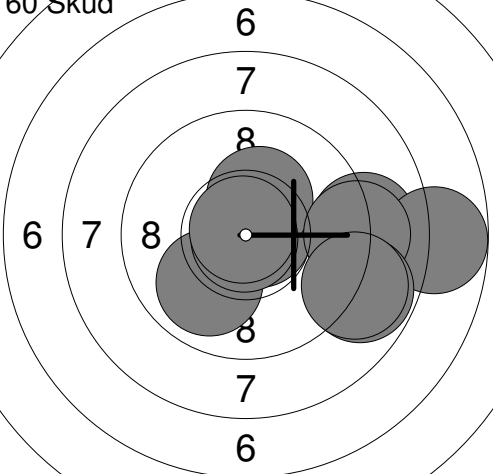
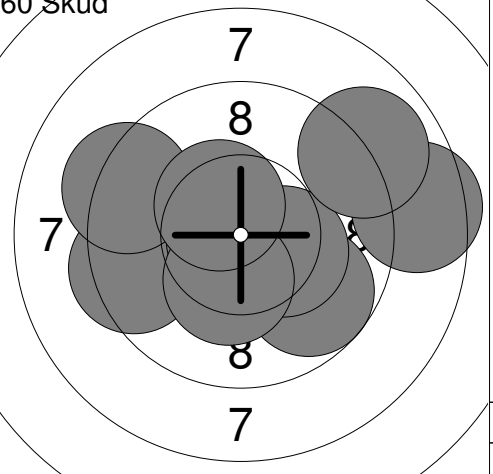
60 Skud 	21: 9.9 ↘ 22: *10.7 → 23: 9.0 → 24: 7.8 → 25: *10.3 ↗ 26: *10.9 ↘ 27: 9.1 → 28: *10.8 ↗ 29: 8.8 ↘ 30: 8.9 ↘ <hr/> Serie 90.0 Total 271.0	60 Skud 	31: 10.0 ← 32: 9.4 ← 33: 9.7 ↘ 34: *10.8 ← 35: *10.3 ↘ 36: *10.3 ↘ 37: 8.5 → 38: 9.3 ← 39: *10.5 ↗ 40: 8.9 ↗ <hr/> Serie 93.0 Total 364.0
--	---	--	--

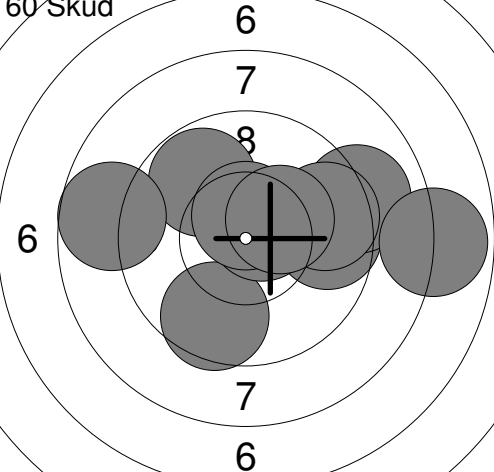
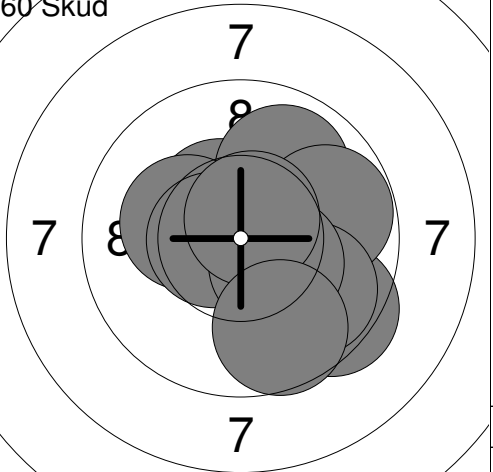
60 Skud 	41: 9.6 → 42: 9.0 → 43: 7.9 → 44: 9.6 ↘ 45: 9.8 ↗ 46: 8.7 ← 47: 9.6 → 48: *10.6 ↗ 49: *10.6 ↑ 50: *10.3 ↗ <hr/> Serie 90.0 Total 454.0	60 Skud 	51: 9.4 ↘ 52: *10.4 ↗ 53: 9.9 ↗ 54: 9.8 → 55: 9.8 ↘ 56: *10.2 ← 57: *10.6 ← 58: *10.4 ↘ 59: *10.7 ↗ 60: 9.7 ↘ <hr/> Serie 95.0 Total 549.0
--	---	--	---

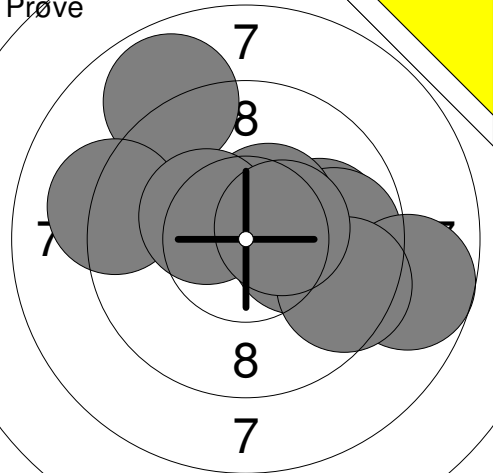
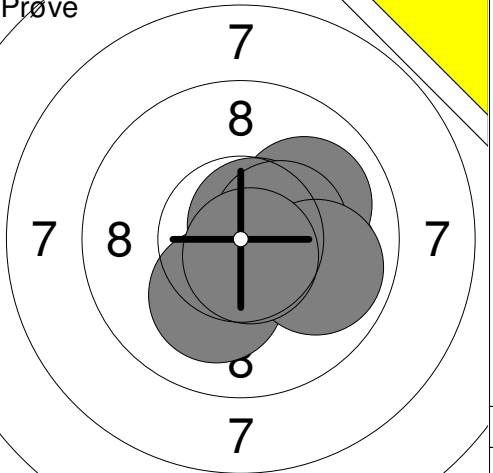
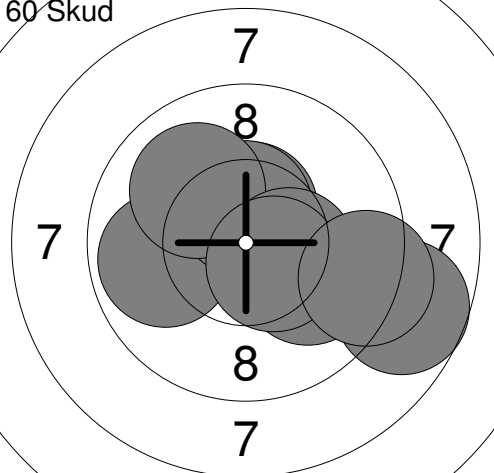
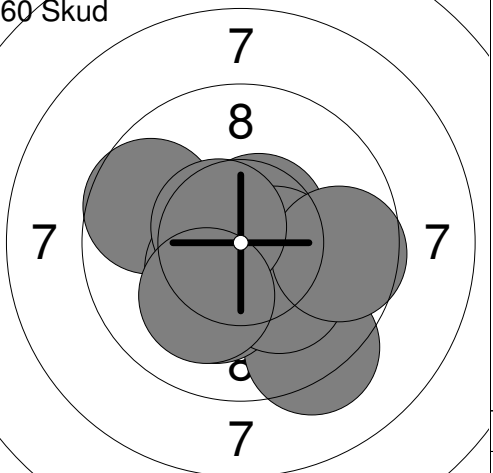
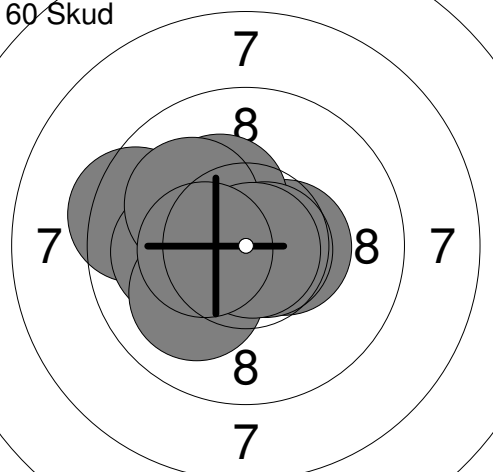
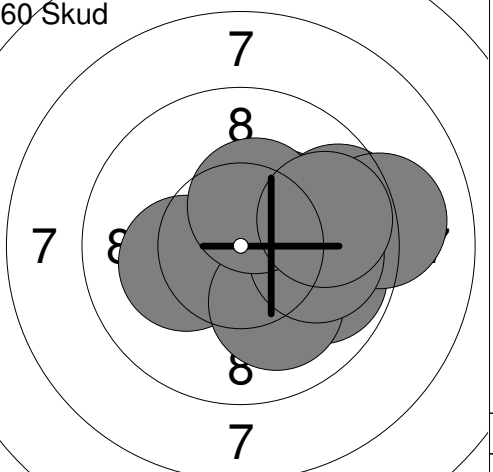
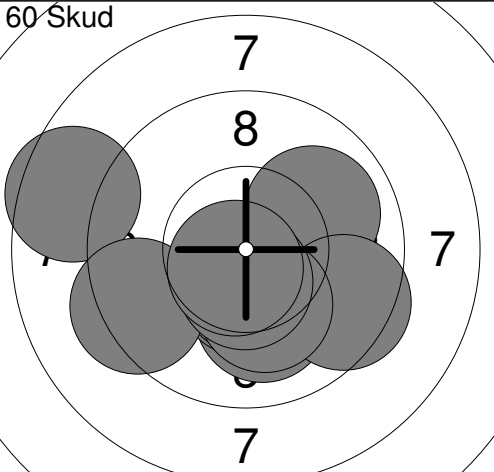
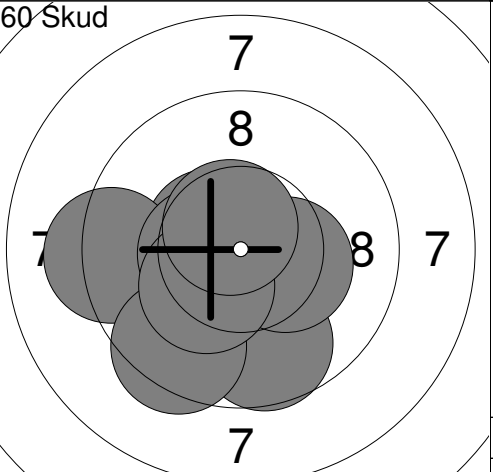
Prøve	Prøve	
		
1: 8.9 ↗ 2: 10.0 → 3: 9.2 ← 4: *10.3 → 5: 9.8 → 6: *10.5 ↗ 7: 8.7 → 8: 9.5 ↘ 9: *10.4 ↗ 10: *10.4 → Serie 93.0 Total 0.0	11: 10.0 ↗ 12: *10.7 ↗ 13: 10.1 ↓ 14: *10.4 → 15: 9.9 → 16: *10.7 ↓ Serie 59.0 Total 0.0	
		
1: *10.5 ↑ 2: 10.0 ↘ 3: 8.7 ↘ 4: *10.6 ↗ 5: 9.9 ← 6: *10.5 ↑ 7: 10.0 ↗ 8: *10.4 ↘ 9: *10.5 ↘ 10: 9.3 ↘ Serie 96.0 Total 96.0	11: 9.7 ← 12: *10.4 ↘ 13: 9.3 ↘ 14: *10.2 ↓ 15: *10.6 ↗ 16: *10.5 → 17: *10.2 ↓ 18: 9.6 → 19: *10.6 ↗ 20: 10.1 ↓ Serie 97.0 Total 193.0	
		
21: *10.4 → 22: 10.1 ← 23: *10.3 ↗ 24: 9.4 ← 25: 10.1 ← 26: 10.1 ↗ 27: *10.7 → 28: 10.1 ↘ 29: *10.8 ↘ 30: *10.4 ← Serie 99.0 Total 292.0	31: 9.8 → 32: *10.7 ↗ 33: *10.3 ↗ 34: *10.2 ← 35: 10.1 ↓ 36: 9.6 → 37: 9.1 → 38: 9.9 → 39: *10.4 ↑ 40: 9.8 → Serie 95.0 Total 387.0	
		
41: 10.1 ↓ 42: 10.0 → 43: *10.4 ↓ 44: *10.4 ↓ 45: 8.6 ↗ 46: 9.5 ↘ 47: 9.3 ← 48: *10.2 ↓ 49: *10.5 ↓ 50: *10.7 ↓ Serie 96.0 Total 483.0	51: *10.3 ← 52: *10.5 ← 53: *10.2 ← 54: 9.7 ↓ 55: 9.2 ← 56: 9.4 ↘ 57: *10.5 ← 58: *10.3 → 59: *10.3 ↘ 60: *10.6 ↗ Serie 97.0 Total 580.0	

<p>Prøve</p>	<p>1: *10.2 →</p> <p>2: *10.4 ↘</p> <p>3: 9.3 ↙</p> <p>4: 9.2 →</p> <p>5: 7.6 ↘</p> <p>6: 9.2 ↓</p> <p>7: 10.0 ↘</p> <p>8: 8.9 →</p> <p>9: 8.7 →</p> <p>10: 9.7 →</p>	<p>Prøve</p>	<p>11: 9.6 ↙</p> <p>12: *10.4 ↘</p> <p>13: 10.0 ↙</p> <p>14: *10.3 →</p> <p>15: 9.4 ↘</p>
Serie	89.0	Serie	48.0
Total	0.0	Total	0.0

<p>60 Skud</p>	<p>1: 9.9 ↗</p> <p>2: *10.4 ↙</p> <p>3: 8.8 ↙</p> <p>4: 9.3 ↘</p> <p>5: 9.2 →</p> <p>6: 8.3 →</p> <p>7: *10.6 ↙</p> <p>8: *10.9 ↗</p> <p>9: 9.8 ↗</p> <p>10: 9.1 ↗</p>	<p>60 Skud</p>	<p>11: 10.1 →</p> <p>12: *10.3 ↗</p> <p>13: 10.1 ↙</p> <p>14: 8.8 ↗</p> <p>15: 9.2 ↗</p> <p>16: 8.6 ↓</p> <p>17: 10.0 ↗</p> <p>18: 9.4 ↓</p> <p>19: *10.3 →</p> <p>20: 9.2 →</p>
Serie	91.0	Serie	93.0
Total	91.0	Total	184.0

<p>60 Skud</p>	<p>21: 9.3 ↘</p> <p>22: 9.4 ↙</p> <p>23: 9.0 →</p> <p>24: 9.6 ↙</p> <p>25: 8.1 ↗</p> <p>26: 9.6 ↗</p> <p>27: 9.8 →</p> <p>28: *10.7 ↗</p> <p>29: *10.4 ↗</p> <p>30: 9.0 ↙</p>	<p>60 Skud</p>	<p>31: 9.3 ↗</p> <p>32: 9.5 ↗</p> <p>33: 9.6 ↓</p> <p>34: 9.8 ↓</p> <p>35: 9.6 ↙</p> <p>36: 10.0 →</p> <p>37: 9.7 →</p> <p>38: *10.2 ↙</p> <p>39: 8.8 →</p> <p>40: 10.1 ↗</p>
Serie	91.0	Serie	92.0
Total	275.0	Total	367.0

<p>60 Skud</p>	<p>41: *10.2 ↘</p> <p>42: 8.9 ↙</p> <p>43: 9.3 ↙</p> <p>44: *10.2 →</p> <p>45: 8.7 ↙</p> <p>46: 9.8 ↗</p> <p>47: 9.7 →</p> <p>48: 9.8 →</p> <p>49: 9.5 →</p> <p>50: 9.9 ↓</p>	<p>60 Skud</p>	<p>51: *10.9 →</p> <p>52: *10.4 ↗</p> <p>53: 9.7 →</p> <p>54: 9.2 ↙</p> <p>55: 9.6 ↗</p> <p>56: 8.4 ↗</p> <p>57: 10.0 ↗</p> <p>58: *10.2 →</p> <p>59: 9.6 ↙</p> <p>60: 9.1 ↘</p>
Serie	90.0	Serie	93.0
Total	457.0	Total	550.0

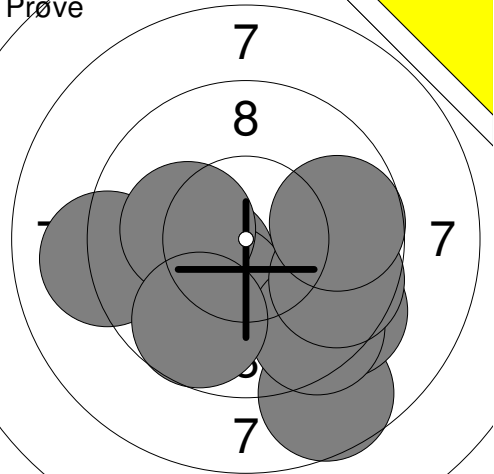
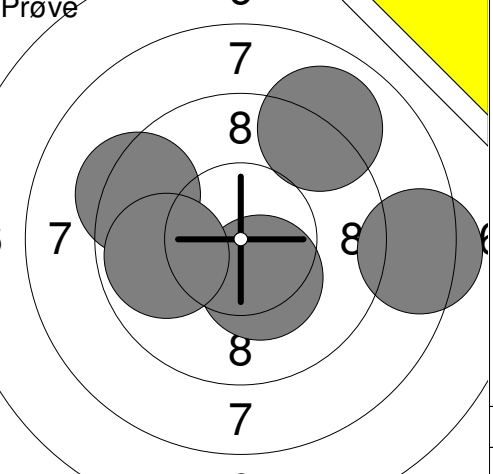
<p>Prøve</p> 	<p>1: 8.6 ↘ 2: *10.4 ↙ 3: 9.1 ← 4: 9.4 ↘ 5: *10.2 ↘ 6: 9.5 ↘ 7: *10.2 ← 8: 9.6 → 9: 9.7 → 10: 9.7 ↘</p> <p>Serie 92.0 Total 0.0</p>	<p>Prøve</p> 	<p>11: 9.0 ↗ 12: *10.3 ↘ 13: 8.4 → 14: 9.3 ↙ 15: 9.9 ←</p> <p>Serie 45.0 Total 0.0</p>
---	---	---	--

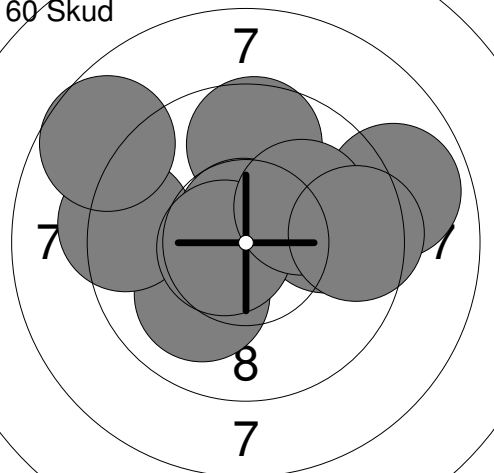
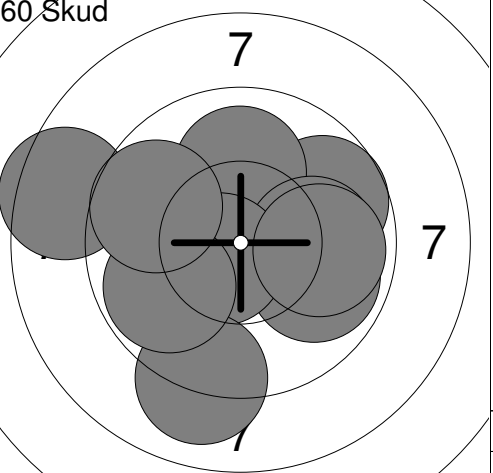
<p>60 Skud</p> 	<p>1: 9.6 ↑ 2: 10.1 ↘ 3: 9.3 ← 4: *10.7 ↑ 5: 8.7 ↗ 6: 9.9 → 7: *10.7 ← 8: 8.9 → 9: 10.1 ↗ 10: 9.5 →</p> <p>Serie 92.0 Total 92.0</p>	<p>60 Skud</p> 	<p>11: 9.7 ↗ 12: 10.0 ↑ 13: 9.9 → 14: 10.0 → 15: 8.5 ← 16: *10.6 ↙ 17: 9.0 ↘ 18: 9.8 ↙ 19: 9.7 ↙ 20: 9.9 →</p> <p>Serie 92.0 Total 184.0</p>
--	--	--	--

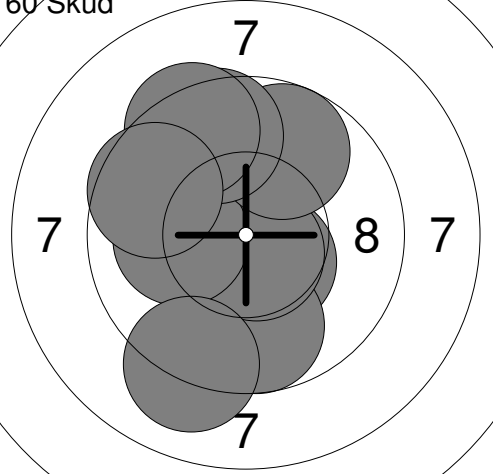
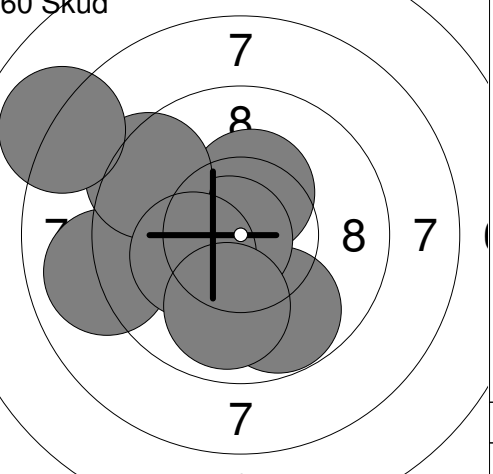
<p>60 Skud</p> 	<p>21: *10.5 ↘ 22: 9.7 ↘ 23: 9.4 ↗ 24: *10.7 ↘ 25: 10.1 ← 26: 9.8 ↗ 27: 9.6 ↗ 28: 9.4 ↗ 29: 9.1 ↘ 30: 9.6 ↗</p> <p>Serie 93.0 Total 277.0</p>	<p>60 Skud</p> 	<p>31: 10.1 ← 32: 9.8 ↘ 33: *10.7 ← 34: *10.3 ↑ 35: *10.8 ← 36: 9.0 ← 37: 9.4 ↗ 38: *10.2 ← 39: 8.0 ↙ 40: 9.9 ↘</p> <p>Serie 94.0 Total 371.0</p>
---	---	---	---

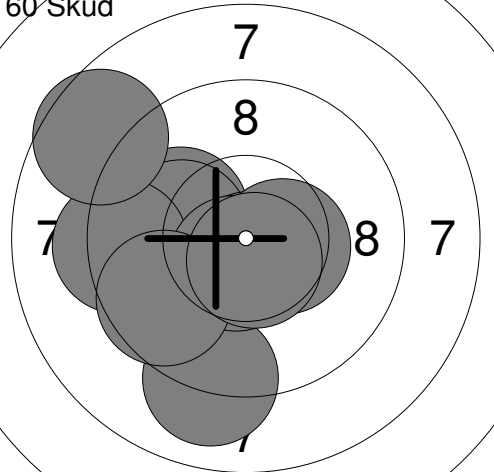
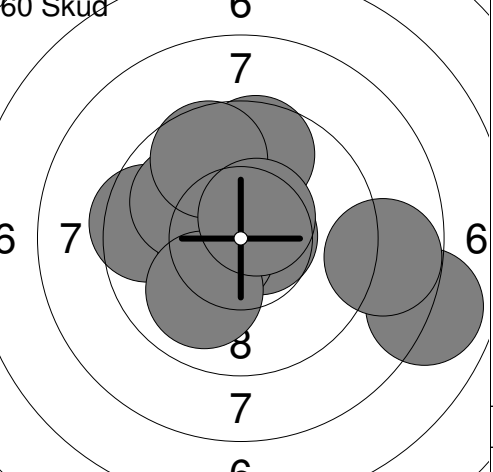
<p>60 Skud</p> 	<p>41: 10.0 ← 42: 9.0 ↘ 43: 10.1 ← 44: 9.3 ← 45: *10.7 ↘ 46: *10.6 ↘ 47: 9.6 ↙ 48: 8.6 ↗ 49: *10.4 → 50: *10.6 ↘</p> <p>Serie 95.0 Total 466.0</p>	<p>60 Skud</p> 	<p>51: 9.6 ↑ 52: *10.7 → 53: 9.5 ← 54: *10.5 ↙ 55: 10.0 ↗ 56: 8.0 → 57: 8.8 → 58: 9.7 ↗ 59: 10.0 ↘ 60: *10.5 ↗</p> <p>Serie 93.0 Total 559.0</p>
---	--	---	--

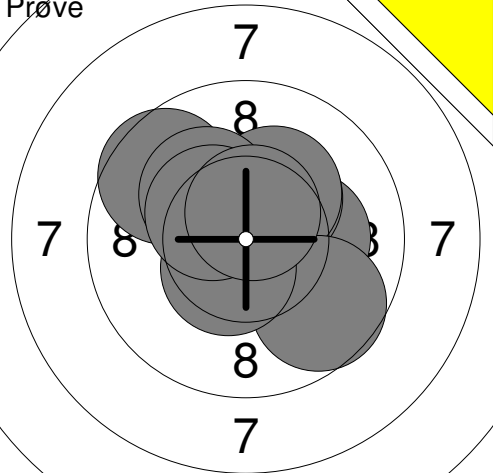
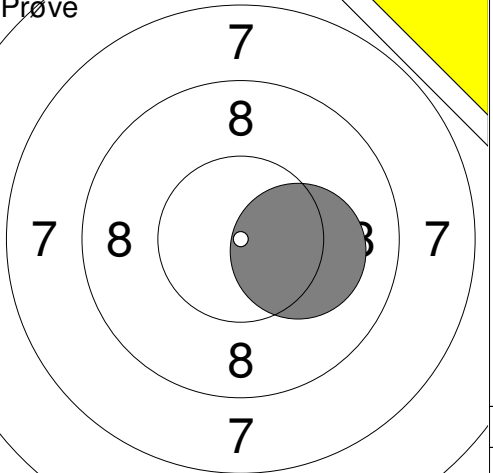
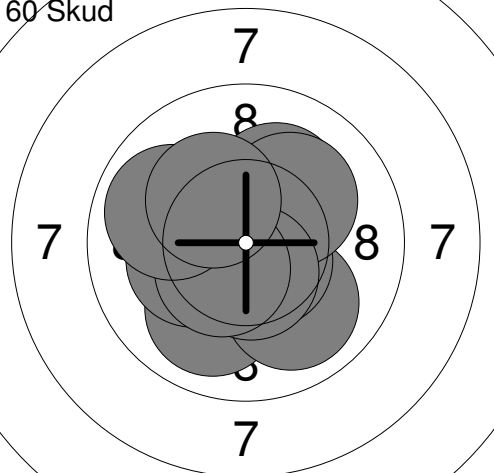
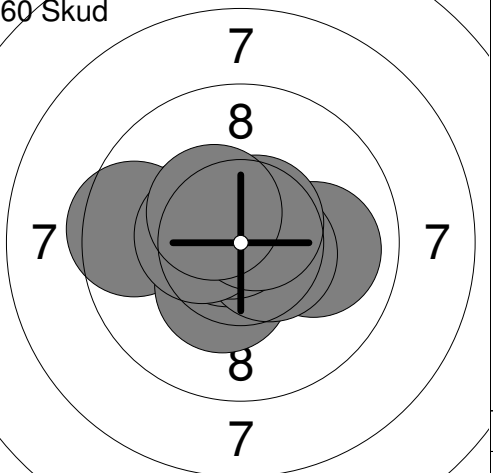
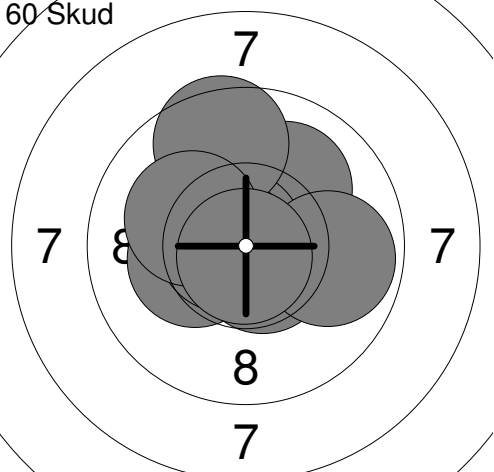
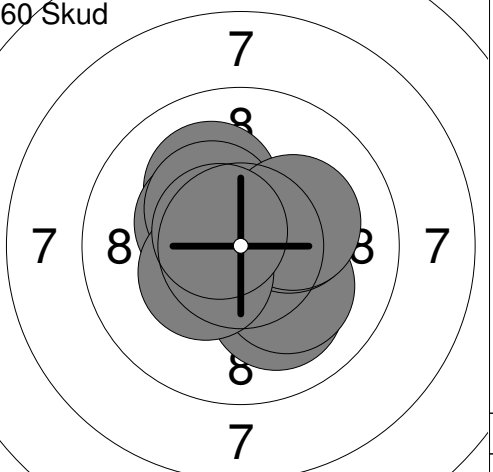
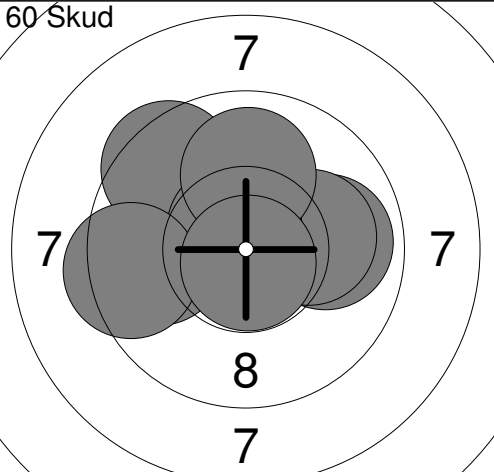
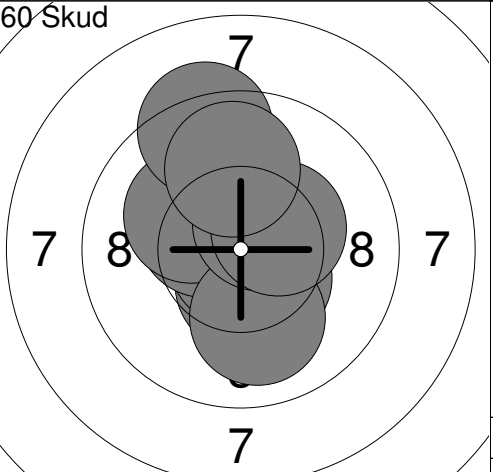

<p>Prøve</p> 	<p>1: *10.2 → 2: *10.3 ↗ 3: 9.6 ↗ 4: *10.7 ↑ 5: *10.2 ↗ 6: *10.2 ↗ 7: 9.7 ↓ 8: *10.5 ↓ 9: *10.4 ↗ 10: *10.6 ↑</p> <p>Serie 98.0 Total 0.0</p>	<p>Prøve</p> 	<p>11: *10.2 →</p> <p>Serie 10.0 Total 0.0</p>
<p>60 Skud</p> 	<p>1: 10.0 ↓ 2: 10.0 ↓ 3: *10.6 ↓ 4: *10.2 ↗ 5: 10.1 ↗ 6: *10.6 ↓ 7: *10.2 ← 8: *10.5 ↓ 9: 9.9 ← 10: *10.2 ↗</p> <p>Serie 99.0 Total 99.0</p>	<p>60 Skud</p> 	<p>11: *10.3 ← 12: 9.5 ← 13: *10.3 ↓ 14: 10.0 → 15: *10.8 ← 16: *10.5 ↘ 17: *10.8 ↗ 18: *10.4 ← 19: *10.6 ↗ 20: *10.4 ↗</p> <p>Serie 99.0 Total 198.0</p>
<p>60 Skud</p> 	<p>21: *10.3 ← 22: *10.8 ↓ 23: 10.0 ↗ 24: *10.6 ↓ 25: *10.8 ↗ 26: *10.7 ← 27: 9.6 ↑ 28: *10.2 ↗ 29: 9.9 → 30: *10.8 ↓</p> <p>Serie 98.0 Total 296.0</p>	<p>60 Skud</p> 	<p>31: 10.1 ↗ 32: 10.1 ↓ 33: *10.6 → 34: *10.4 ↗ 35: 10.1 ↓ 36: *10.2 → 37: *10.3 ↗ 38: *10.2 → 39: *10.4 ← 40: *10.6 ↗</p> <p>Serie 100.0 Total 396.0</p>
<p>60 Skud</p> 	<p>41: 9.9 → 42: 10.1 → 43: 10.0 ↗ 44: *10.8 ← 45: 9.8 ← 46: 9.5 ↗ 47: *10.7 ↗ 48: 9.4 ← 49: 10.0 ↑ 50: *10.8 ↓</p> <p>Serie 96.0 Total 492.0</p>	<p>60 Skud</p> 	<p>51: *10.5 ↓ 52: *10.5 ↓ 53: *10.8 ↓ 54: *10.4 ← 55: *10.2 ↗ 56: 9.3 ↑ 57: 10.0 ↓ 58: *10.5 ↗ 59: *10.4 ↗ 60: 9.9 ↑</p> <p>Serie 98.0 Total 590.0</p>

<p>Prøve</p>	<table border="1" style="width:100%; border-collapse: collapse;"> <tr><td>1:</td><td>4.8</td><td>↓</td></tr> <tr><td>2:</td><td>8.4</td><td>↓</td></tr> <tr><td>3:</td><td>10.1</td><td>↗</td></tr> <tr><td>4:</td><td>9.0</td><td>↓</td></tr> <tr><td>5:</td><td>9.8</td><td>→</td></tr> <tr><td>6:</td><td>9.8</td><td>←</td></tr> <tr><td>7:</td><td>9.7</td><td>↓</td></tr> <tr><td>8:</td><td>9.7</td><td>↘</td></tr> <tr><td>9:</td><td>9.4</td><td>→</td></tr> <tr><td>10:</td><td>9.6</td><td>←</td></tr> <tr><td colspan="2">Serie</td><td>85.0</td></tr> <tr><td colspan="2">Total</td><td>0.0</td></tr> </table>	1:	4.8	↓	2:	8.4	↓	3:	10.1	↗	4:	9.0	↓	5:	9.8	→	6:	9.8	←	7:	9.7	↓	8:	9.7	↘	9:	9.4	→	10:	9.6	←	Serie		85.0	Total		0.0	<p>Prøve</p>	<table border="1" style="width:100%; border-collapse: collapse;"> <tr><td>11:</td><td>9.2</td><td>→</td></tr> <tr><td>12:</td><td>9.6</td><td>↗</td></tr> <tr><td>13:</td><td>9.6</td><td>↑</td></tr> <tr><td>14:</td><td>9.9</td><td>↗</td></tr> <tr><td>15:</td><td>*10.6</td><td>↗</td></tr> <tr><td>16:</td><td>*10.7</td><td>↖</td></tr> <tr><td>17:</td><td>10.1</td><td>↑</td></tr> <tr><td>18:</td><td>9.5</td><td>↖</td></tr> <tr><td colspan="2">Serie</td><td>75.0</td></tr> <tr><td colspan="2">Total</td><td>0.0</td></tr> </table>	11:	9.2	→	12:	9.6	↗	13:	9.6	↑	14:	9.9	↗	15:	*10.6	↗	16:	*10.7	↖	17:	10.1	↑	18:	9.5	↖	Serie		75.0	Total		0.0
1:	4.8	↓																																																																			
2:	8.4	↓																																																																			
3:	10.1	↗																																																																			
4:	9.0	↓																																																																			
5:	9.8	→																																																																			
6:	9.8	←																																																																			
7:	9.7	↓																																																																			
8:	9.7	↘																																																																			
9:	9.4	→																																																																			
10:	9.6	←																																																																			
Serie		85.0																																																																			
Total		0.0																																																																			
11:	9.2	→																																																																			
12:	9.6	↗																																																																			
13:	9.6	↑																																																																			
14:	9.9	↗																																																																			
15:	*10.6	↗																																																																			
16:	*10.7	↖																																																																			
17:	10.1	↑																																																																			
18:	9.5	↖																																																																			
Serie		75.0																																																																			
Total		0.0																																																																			

<p>60 Skud</p>	<table border="1" style="width:100%; border-collapse: collapse;"> <tr><td>1:</td><td>9.5</td><td>↖</td></tr> <tr><td>2:</td><td>7.8</td><td>←</td></tr> <tr><td>3:</td><td>9.3</td><td>↑</td></tr> <tr><td>4:</td><td>*10.5</td><td>↗</td></tr> <tr><td>5:</td><td>*10.5</td><td>→</td></tr> <tr><td>6:</td><td>9.6</td><td>→</td></tr> <tr><td>7:</td><td>10.1</td><td>→</td></tr> <tr><td>8:</td><td>9.8</td><td>↑</td></tr> <tr><td>9:</td><td>9.5</td><td>↗</td></tr> <tr><td>10:</td><td>9.5</td><td>↓</td></tr> <tr><td colspan="2">Serie</td><td>91.0</td></tr> <tr><td colspan="2">Total</td><td>91.0</td></tr> </table>	1:	9.5	↖	2:	7.8	←	3:	9.3	↑	4:	*10.5	↗	5:	*10.5	→	6:	9.6	→	7:	10.1	→	8:	9.8	↑	9:	9.5	↗	10:	9.5	↓	Serie		91.0	Total		91.0	<p>60 Skud</p>	<table border="1" style="width:100%; border-collapse: collapse;"> <tr><td>11:</td><td>9.3</td><td>→</td></tr> <tr><td>12:</td><td>*10.5</td><td>←</td></tr> <tr><td>13:</td><td>*10.4</td><td>←</td></tr> <tr><td>14:</td><td>*10.4</td><td>↗</td></tr> <tr><td>15:</td><td>10.0</td><td>←</td></tr> <tr><td>16:</td><td>9.6</td><td>↘</td></tr> <tr><td>17:</td><td>9.7</td><td>↗</td></tr> <tr><td>18:</td><td>*10.2</td><td>→</td></tr> <tr><td>19:</td><td>*10.3</td><td>↓</td></tr> <tr><td>20:</td><td>8.8</td><td>→</td></tr> <tr><td colspan="2">Serie</td><td>95.0</td></tr> <tr><td colspan="2">Total</td><td>186.0</td></tr> </table>	11:	9.3	→	12:	*10.5	←	13:	*10.4	←	14:	*10.4	↗	15:	10.0	←	16:	9.6	↘	17:	9.7	↗	18:	*10.2	→	19:	*10.3	↓	20:	8.8	→	Serie		95.0	Total		186.0
1:	9.5	↖																																																																									
2:	7.8	←																																																																									
3:	9.3	↑																																																																									
4:	*10.5	↗																																																																									
5:	*10.5	→																																																																									
6:	9.6	→																																																																									
7:	10.1	→																																																																									
8:	9.8	↑																																																																									
9:	9.5	↗																																																																									
10:	9.5	↓																																																																									
Serie		91.0																																																																									
Total		91.0																																																																									
11:	9.3	→																																																																									
12:	*10.5	←																																																																									
13:	*10.4	←																																																																									
14:	*10.4	↗																																																																									
15:	10.0	←																																																																									
16:	9.6	↘																																																																									
17:	9.7	↗																																																																									
18:	*10.2	→																																																																									
19:	*10.3	↓																																																																									
20:	8.8	→																																																																									
Serie		95.0																																																																									
Total		186.0																																																																									

<p>60 Skud</p>	<table border="1" style="width:100%; border-collapse: collapse;"> <tr><td>21:</td><td>9.9</td><td>→</td></tr> <tr><td>22:</td><td>9.4</td><td>→</td></tr> <tr><td>23:</td><td>*10.4</td><td>↘</td></tr> <tr><td>24:</td><td>9.6</td><td>↘</td></tr> <tr><td>25:</td><td>10.1</td><td>→</td></tr> <tr><td>26:</td><td>8.5</td><td>←</td></tr> <tr><td>27:</td><td>*10.8</td><td>↗</td></tr> <tr><td>28:</td><td>*10.5</td><td>↓</td></tr> <tr><td>29:</td><td>*10.6</td><td>↘</td></tr> <tr><td>30:</td><td>9.6</td><td>←</td></tr> <tr><td colspan="2">Serie</td><td>94.0</td></tr> <tr><td colspan="2">Total</td><td>280.0</td></tr> </table>	21:	9.9	→	22:	9.4	→	23:	*10.4	↘	24:	9.6	↘	25:	10.1	→	26:	8.5	←	27:	*10.8	↗	28:	*10.5	↓	29:	*10.6	↘	30:	9.6	←	Serie		94.0	Total		280.0	<p>60 Skud</p>	<table border="1" style="width:100%; border-collapse: collapse;"> <tr><td>31:</td><td>*10.7</td><td>↗</td></tr> <tr><td>32:</td><td>10.0</td><td>→</td></tr> <tr><td>33:</td><td>*10.6</td><td>↓</td></tr> <tr><td>34:</td><td>10.1</td><td>↑</td></tr> <tr><td>35:</td><td>10.1</td><td>←</td></tr> <tr><td>36:</td><td>9.8</td><td>←</td></tr> <tr><td>37:</td><td>9.4</td><td>↘</td></tr> <tr><td>38:</td><td>9.7</td><td>←</td></tr> <tr><td>39:</td><td>*10.3</td><td>←</td></tr> <tr><td>40:</td><td>10.0</td><td>↑</td></tr> <tr><td colspan="2">Serie</td><td>97.0</td></tr> <tr><td colspan="2">Total</td><td>377.0</td></tr> </table>	31:	*10.7	↗	32:	10.0	→	33:	*10.6	↓	34:	10.1	↑	35:	10.1	←	36:	9.8	←	37:	9.4	↘	38:	9.7	←	39:	*10.3	←	40:	10.0	↑	Serie		97.0	Total		377.0
21:	9.9	→																																																																									
22:	9.4	→																																																																									
23:	*10.4	↘																																																																									
24:	9.6	↘																																																																									
25:	10.1	→																																																																									
26:	8.5	←																																																																									
27:	*10.8	↗																																																																									
28:	*10.5	↓																																																																									
29:	*10.6	↘																																																																									
30:	9.6	←																																																																									
Serie		94.0																																																																									
Total		280.0																																																																									
31:	*10.7	↗																																																																									
32:	10.0	→																																																																									
33:	*10.6	↓																																																																									
34:	10.1	↑																																																																									
35:	10.1	←																																																																									
36:	9.8	←																																																																									
37:	9.4	↘																																																																									
38:	9.7	←																																																																									
39:	*10.3	←																																																																									
40:	10.0	↑																																																																									
Serie		97.0																																																																									
Total		377.0																																																																									

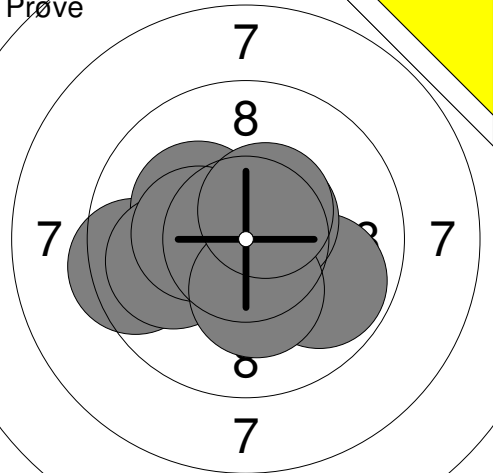
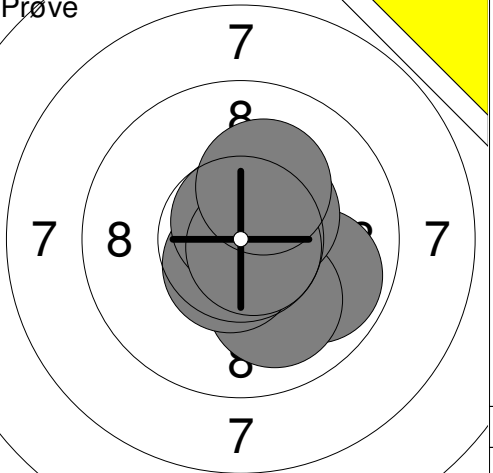
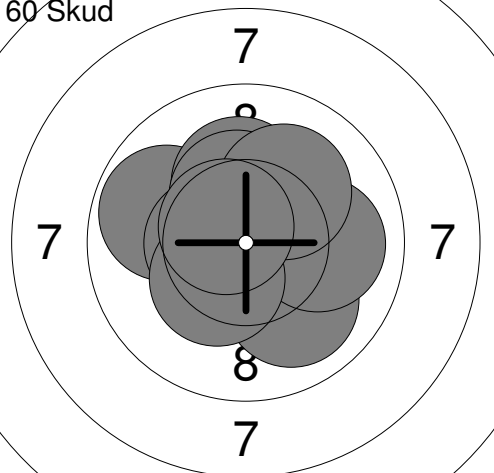
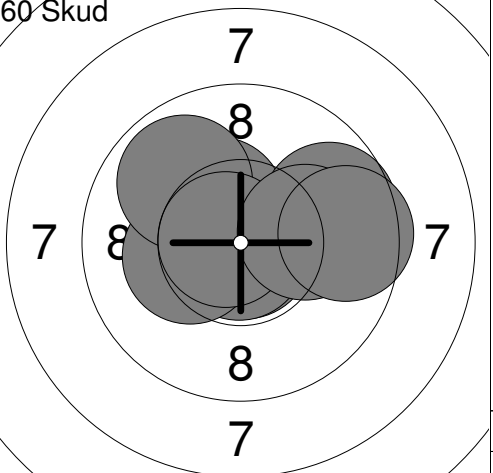
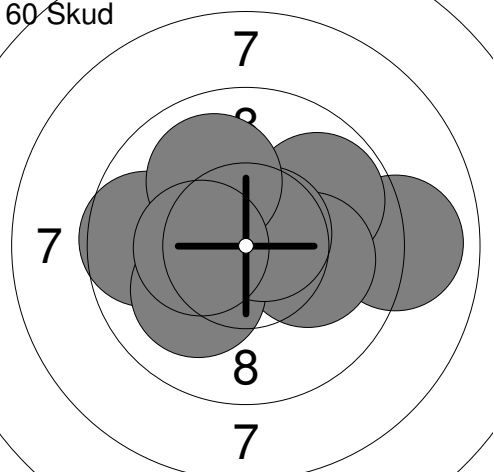
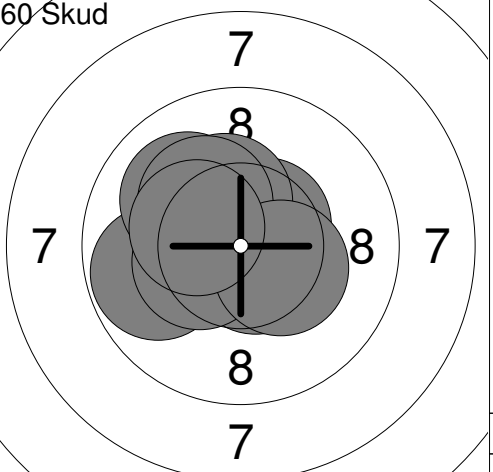
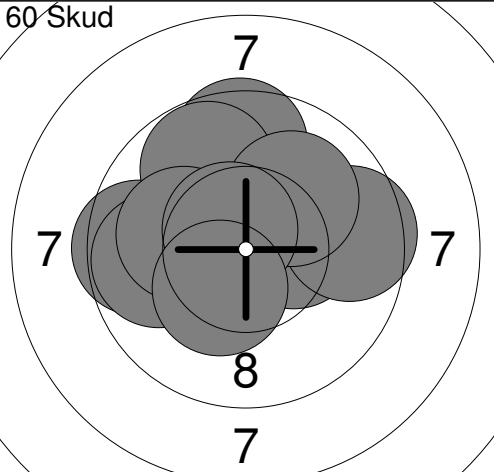
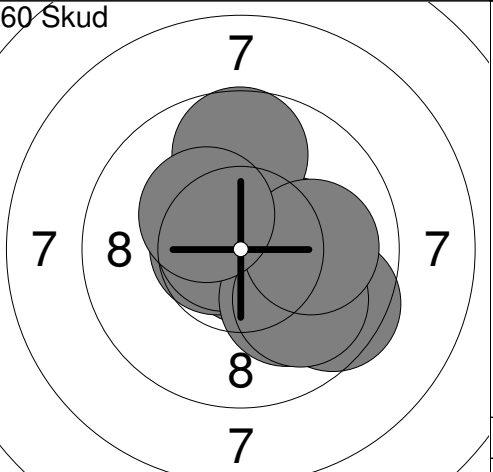
<p>60 Skud</p>	<table border="1" style="width:100%; border-collapse: collapse;"> <tr><td>41:</td><td>9.8</td><td>→</td></tr> <tr><td>42:</td><td>9.3</td><td>↗</td></tr> <tr><td>43:</td><td>9.7</td><td>↖</td></tr> <tr><td>44:</td><td>*10.2</td><td>↘</td></tr> <tr><td>45:</td><td>*10.3</td><td>↘</td></tr> <tr><td>46:</td><td>9.9</td><td>↗</td></tr> <tr><td>47:</td><td>9.9</td><td>↘</td></tr> <tr><td>48:</td><td>10.1</td><td>↗</td></tr> <tr><td>49:</td><td>*10.4</td><td>→</td></tr> <tr><td>50:</td><td>*10.3</td><td>↓</td></tr> <tr><td colspan="2">Serie</td><td>95.0</td></tr> <tr><td colspan="2">Total</td><td>472.0</td></tr> </table>	41:	9.8	→	42:	9.3	↗	43:	9.7	↖	44:	*10.2	↘	45:	*10.3	↘	46:	9.9	↗	47:	9.9	↘	48:	10.1	↗	49:	*10.4	→	50:	*10.3	↓	Serie		95.0	Total		472.0	<p>60 Skud</p>	<table border="1" style="width:100%; border-collapse: collapse;"> <tr><td>51:</td><td>9.8</td><td>↓</td></tr> <tr><td>52:</td><td>*10.4</td><td>↓</td></tr> <tr><td>53:</td><td>9.7</td><td>↗</td></tr> <tr><td>54:</td><td>9.7</td><td>↑</td></tr> <tr><td>55:</td><td>8.8</td><td>↓</td></tr> <tr><td>56:</td><td>*10.2</td><td>→</td></tr> <tr><td>57:</td><td>*10.3</td><td>↗</td></tr> <tr><td>58:</td><td>*10.2</td><td>→</td></tr> <tr><td>59:</td><td>9.1</td><td>→</td></tr> <tr><td>60:</td><td>*10.6</td><td>↘</td></tr> <tr><td colspan="2">Serie</td><td>94.0</td></tr> <tr><td colspan="2">Total</td><td>566.0</td></tr> </table>	51:	9.8	↓	52:	*10.4	↓	53:	9.7	↗	54:	9.7	↑	55:	8.8	↓	56:	*10.2	→	57:	*10.3	↗	58:	*10.2	→	59:	9.1	→	60:	*10.6	↘	Serie		94.0	Total		566.0
41:	9.8	→																																																																									
42:	9.3	↗																																																																									
43:	9.7	↖																																																																									
44:	*10.2	↘																																																																									
45:	*10.3	↘																																																																									
46:	9.9	↗																																																																									
47:	9.9	↘																																																																									
48:	10.1	↗																																																																									
49:	*10.4	→																																																																									
50:	*10.3	↓																																																																									
Serie		95.0																																																																									
Total		472.0																																																																									
51:	9.8	↓																																																																									
52:	*10.4	↓																																																																									
53:	9.7	↗																																																																									
54:	9.7	↑																																																																									
55:	8.8	↓																																																																									
56:	*10.2	→																																																																									
57:	*10.3	↗																																																																									
58:	*10.2	→																																																																									
59:	9.1	→																																																																									
60:	*10.6	↘																																																																									
Serie		94.0																																																																									
Total		566.0																																																																									

Prøve	Prøve																											
		<table style="width:100%; border-collapse: collapse;"> <tr><td>1: 9.8</td><td style="text-align:right;">↘</td></tr> <tr><td>2: 9.4</td><td style="text-align:right;">←</td></tr> <tr><td>3: *10.2</td><td style="text-align:right;">↗</td></tr> <tr><td>4: *10.4</td><td style="text-align:right;">←</td></tr> <tr><td>5: 9.9</td><td style="text-align:right;">←</td></tr> <tr><td>6: *10.3</td><td style="text-align:right;">←</td></tr> <tr><td>7: *10.5</td><td style="text-align:right;">↗</td></tr> <tr><td>8: *10.3</td><td style="text-align:right;">↓</td></tr> <tr><td>10: *10.5</td><td style="text-align:right;">↗</td></tr> <tr><td colspan="2"><hr/></td></tr> <tr><td>Serie</td><td style="text-align:right;">87.0</td></tr> <tr><td>Total</td><td style="text-align:right;">0.0</td></tr> </table>	1: 9.8	↘	2: 9.4	←	3: *10.2	↗	4: *10.4	←	5: 9.9	←	6: *10.3	←	7: *10.5	↗	8: *10.3	↓	10: *10.5	↗	<hr/>		Serie	87.0	Total	0.0		
1: 9.8	↘																											
2: 9.4	←																											
3: *10.2	↗																											
4: *10.4	←																											
5: 9.9	←																											
6: *10.3	←																											
7: *10.5	↗																											
8: *10.3	↓																											
10: *10.5	↗																											
<hr/>																												
Serie	87.0																											
Total	0.0																											
		<table style="width:100%; border-collapse: collapse;"> <tr><td>11: 9.9</td><td style="text-align:right;">↘</td></tr> <tr><td>12: 10.0</td><td style="text-align:right;">↓</td></tr> <tr><td>13: *10.6</td><td style="text-align:right;">↓</td></tr> <tr><td>14: *10.7</td><td style="text-align:right;">↑</td></tr> <tr><td>15: *10.4</td><td style="text-align:right;">↗</td></tr> <tr><td>16: *10.8</td><td style="text-align:right;">↓</td></tr> <tr><td>17: *10.2</td><td style="text-align:right;">↑</td></tr> <tr><td colspan="2"><hr/></td></tr> <tr><td>Serie</td><td style="text-align:right;">69.0</td></tr> <tr><td>Total</td><td style="text-align:right;">0.0</td></tr> </table>	11: 9.9	↘	12: 10.0	↓	13: *10.6	↓	14: *10.7	↑	15: *10.4	↗	16: *10.8	↓	17: *10.2	↑	<hr/>		Serie	69.0	Total	0.0						
11: 9.9	↘																											
12: 10.0	↓																											
13: *10.6	↓																											
14: *10.7	↑																											
15: *10.4	↗																											
16: *10.8	↓																											
17: *10.2	↑																											
<hr/>																												
Serie	69.0																											
Total	0.0																											
		<table style="width:100%; border-collapse: collapse;"> <tr><td>1: 9.8</td><td style="text-align:right;">←</td></tr> <tr><td>2: *10.5</td><td style="text-align:right;">←</td></tr> <tr><td>3: 10.0</td><td style="text-align:right;">↓</td></tr> <tr><td>4: *10.5</td><td style="text-align:right;">↑</td></tr> <tr><td>5: *10.2</td><td style="text-align:right;">↑</td></tr> <tr><td>6: 10.0</td><td style="text-align:right;">→</td></tr> <tr><td>7: *10.3</td><td style="text-align:right;">↑</td></tr> <tr><td>8: *10.3</td><td style="text-align:right;">↓</td></tr> <tr><td>9: 10.1</td><td style="text-align:right;">↗</td></tr> <tr><td>10: *10.6</td><td style="text-align:right;">↖</td></tr> <tr><td colspan="2"><hr/></td></tr> <tr><td>Serie</td><td style="text-align:right;">99.0</td></tr> <tr><td>Total</td><td style="text-align:right;">99.0</td></tr> </table>	1: 9.8	←	2: *10.5	←	3: 10.0	↓	4: *10.5	↑	5: *10.2	↑	6: 10.0	→	7: *10.3	↑	8: *10.3	↓	9: 10.1	↗	10: *10.6	↖	<hr/>		Serie	99.0	Total	99.0
1: 9.8	←																											
2: *10.5	←																											
3: 10.0	↓																											
4: *10.5	↑																											
5: *10.2	↑																											
6: 10.0	→																											
7: *10.3	↑																											
8: *10.3	↓																											
9: 10.1	↗																											
10: *10.6	↖																											
<hr/>																												
Serie	99.0																											
Total	99.0																											
		<table style="width:100%; border-collapse: collapse;"> <tr><td>11: *10.2</td><td style="text-align:right;">↖</td></tr> <tr><td>12: *10.8</td><td style="text-align:right;">↓</td></tr> <tr><td>13: *10.8</td><td style="text-align:right;">↓</td></tr> <tr><td>14: *10.4</td><td style="text-align:right;">↗</td></tr> <tr><td>15: 9.7</td><td style="text-align:right;">→</td></tr> <tr><td>16: *10.3</td><td style="text-align:right;">←</td></tr> <tr><td>17: 9.9</td><td style="text-align:right;">↗</td></tr> <tr><td>18: *10.7</td><td style="text-align:right;">←</td></tr> <tr><td>19: 10.1</td><td style="text-align:right;">→</td></tr> <tr><td>20: 9.6</td><td style="text-align:right;">→</td></tr> <tr><td colspan="2"><hr/></td></tr> <tr><td>Serie</td><td style="text-align:right;">97.0</td></tr> <tr><td>Total</td><td style="text-align:right;">196.0</td></tr> </table>	11: *10.2	↖	12: *10.8	↓	13: *10.8	↓	14: *10.4	↗	15: 9.7	→	16: *10.3	←	17: 9.9	↗	18: *10.7	←	19: 10.1	→	20: 9.6	→	<hr/>		Serie	97.0	Total	196.0
11: *10.2	↖																											
12: *10.8	↓																											
13: *10.8	↓																											
14: *10.4	↗																											
15: 9.7	→																											
16: *10.3	←																											
17: 9.9	↗																											
18: *10.7	←																											
19: 10.1	→																											
20: 9.6	→																											
<hr/>																												
Serie	97.0																											
Total	196.0																											
		<table style="width:100%; border-collapse: collapse;"> <tr><td>21: 9.0</td><td style="text-align:right;">→</td></tr> <tr><td>22: 9.8</td><td style="text-align:right;">↗</td></tr> <tr><td>23: 10.1</td><td style="text-align:right;">→</td></tr> <tr><td>24: *10.4</td><td style="text-align:right;">←</td></tr> <tr><td>25: 9.6</td><td style="text-align:right;">←</td></tr> <tr><td>26: 10.1</td><td style="text-align:right;">↓</td></tr> <tr><td>27: *10.6</td><td style="text-align:right;">↗</td></tr> <tr><td>28: *10.7</td><td style="text-align:right;">↗</td></tr> <tr><td>29: 10.0</td><td style="text-align:right;">↗</td></tr> <tr><td>30: *10.4</td><td style="text-align:right;">←</td></tr> <tr><td colspan="2"><hr/></td></tr> <tr><td>Serie</td><td style="text-align:right;">97.0</td></tr> <tr><td>Total</td><td style="text-align:right;">293.0</td></tr> </table>	21: 9.0	→	22: 9.8	↗	23: 10.1	→	24: *10.4	←	25: 9.6	←	26: 10.1	↓	27: *10.6	↗	28: *10.7	↗	29: 10.0	↗	30: *10.4	←	<hr/>		Serie	97.0	Total	293.0
21: 9.0	→																											
22: 9.8	↗																											
23: 10.1	→																											
24: *10.4	←																											
25: 9.6	←																											
26: 10.1	↓																											
27: *10.6	↗																											
28: *10.7	↗																											
29: 10.0	↗																											
30: *10.4	←																											
<hr/>																												
Serie	97.0																											
Total	293.0																											
		<table style="width:100%; border-collapse: collapse;"> <tr><td>31: 9.8</td><td style="text-align:right;">←</td></tr> <tr><td>32: *10.6</td><td style="text-align:right;">↑</td></tr> <tr><td>33: *10.6</td><td style="text-align:right;">↗</td></tr> <tr><td>34: *10.6</td><td style="text-align:right;">↓</td></tr> <tr><td>35: *10.4</td><td style="text-align:right;">←</td></tr> <tr><td>36: 10.0</td><td style="text-align:right;">↗</td></tr> <tr><td>37: *10.3</td><td style="text-align:right;">↗</td></tr> <tr><td>38: *10.2</td><td style="text-align:right;">↗</td></tr> <tr><td>39: *10.3</td><td style="text-align:right;">↓</td></tr> <tr><td>40: *10.3</td><td style="text-align:right;">↖</td></tr> <tr><td colspan="2"><hr/></td></tr> <tr><td>Serie</td><td style="text-align:right;">99.0</td></tr> <tr><td>Total</td><td style="text-align:right;">392.0</td></tr> </table>	31: 9.8	←	32: *10.6	↑	33: *10.6	↗	34: *10.6	↓	35: *10.4	←	36: 10.0	↗	37: *10.3	↗	38: *10.2	↗	39: *10.3	↓	40: *10.3	↖	<hr/>		Serie	99.0	Total	392.0
31: 9.8	←																											
32: *10.6	↑																											
33: *10.6	↗																											
34: *10.6	↓																											
35: *10.4	←																											
36: 10.0	↗																											
37: *10.3	↗																											
38: *10.2	↗																											
39: *10.3	↓																											
40: *10.3	↖																											
<hr/>																												
Serie	99.0																											
Total	392.0																											
		<table style="width:100%; border-collapse: collapse;"> <tr><td>41: 9.5</td><td style="text-align:right;">←</td></tr> <tr><td>42: 9.8</td><td style="text-align:right;">←</td></tr> <tr><td>43: 9.6</td><td style="text-align:right;">↑</td></tr> <tr><td>44: 9.8</td><td style="text-align:right;">↗</td></tr> <tr><td>45: 10.1</td><td style="text-align:right;">←</td></tr> <tr><td>46: *10.3</td><td style="text-align:right;">→</td></tr> <tr><td>47: 9.6</td><td style="text-align:right;">→</td></tr> <tr><td>48: 10.1</td><td style="text-align:right;">↗</td></tr> <tr><td>49: *10.6</td><td style="text-align:right;">↗</td></tr> <tr><td>50: *10.3</td><td style="text-align:right;">↓</td></tr> <tr><td colspan="2"><hr/></td></tr> <tr><td>Serie</td><td style="text-align:right;">95.0</td></tr> <tr><td>Total</td><td style="text-align:right;">487.0</td></tr> </table>	41: 9.5	←	42: 9.8	←	43: 9.6	↑	44: 9.8	↗	45: 10.1	←	46: *10.3	→	47: 9.6	→	48: 10.1	↗	49: *10.6	↗	50: *10.3	↓	<hr/>		Serie	95.0	Total	487.0
41: 9.5	←																											
42: 9.8	←																											
43: 9.6	↑																											
44: 9.8	↗																											
45: 10.1	←																											
46: *10.3	→																											
47: 9.6	→																											
48: 10.1	↗																											
49: *10.6	↗																											
50: *10.3	↓																											
<hr/>																												
Serie	95.0																											
Total	487.0																											
		<table style="width:100%; border-collapse: collapse;"> <tr><td>51: *10.8</td><td style="text-align:right;">↓</td></tr> <tr><td>52: *10.3</td><td style="text-align:right;">→</td></tr> <tr><td>53: *10.6</td><td style="text-align:right;">←</td></tr> <tr><td>54: *10.7</td><td style="text-align:right;">↗</td></tr> <tr><td>55: 9.7</td><td style="text-align:right;">↑</td></tr> <tr><td>56: 10.1</td><td style="text-align:right;">↓</td></tr> <tr><td>57: 9.5</td><td style="text-align:right;">↓</td></tr> <tr><td>58: 9.9</td><td style="text-align:right;">↓</td></tr> <tr><td>59: 10.0</td><td style="text-align:right;">→</td></tr> <tr><td>60: *10.3</td><td style="text-align:right;">↗</td></tr> <tr><td colspan="2"><hr/></td></tr> <tr><td>Serie</td><td style="text-align:right;">97.0</td></tr> <tr><td>Total</td><td style="text-align:right;">584.0</td></tr> </table>	51: *10.8	↓	52: *10.3	→	53: *10.6	←	54: *10.7	↗	55: 9.7	↑	56: 10.1	↓	57: 9.5	↓	58: 9.9	↓	59: 10.0	→	60: *10.3	↗	<hr/>		Serie	97.0	Total	584.0
51: *10.8	↓																											
52: *10.3	→																											
53: *10.6	←																											
54: *10.7	↗																											
55: 9.7	↑																											
56: 10.1	↓																											
57: 9.5	↓																											
58: 9.9	↓																											
59: 10.0	→																											
60: *10.3	↗																											
<hr/>																												
Serie	97.0																											
Total	584.0																											

Prøve 	1: 8.0 → 2: 9.6 ↓ 3: *10.3 ↑ 4: 7.4 ← 5: 5.8 → 6: 9.9 ↓ 7: 8.3 ↘ 8: 9.6 → 9: *10.2 ↗ 10: 8.7 ↗ <hr/> Serie 83.0 Total 0.0	Prøve 	11: 8.8 ↑ 12: 9.1 → 13: 8.2 ← 14: 8.7 ↘ 15: 6.7 → 16: 7.8 ↘ 17: 8.2 → 18: 7.2 ← 19: 6.4 ↓ 20: 8.4 → <hr/> Serie 75.0 Total 0.0
-----------	--	-----------	---

Prøve 	21: 8.3 ↗ 22: 6.6 ↓ 23: 7.0 ↗ 24: *10.2 ↑ 25: 8.7 ↘ 26: 8.8 ↓ 27: *10.4 → <hr/> Serie 57.0 Total 0.0	60 Skud 	1: 9.1 → 2: 10.0 ↓ 3: *10.6 ← 4: 9.7 ↑ 5: 10.0 ↓ 6: *10.5 ↗ 7: 9.5 ← 8: 5.5 ↘ 9: 9.9 ↑ 10: 9.0 ← <hr/> Serie 90.0 Total 90.0
-----------	--	-------------	---

60 Skud 	11: 9.5 ↗ 12: 7.4 ← 13: 9.7 ↘ 14: 7.1 → 15: *10.5 ← 16: 9.2 ← 17: 8.4 ↘ 18: *10.5 ↗ 19: 8.8 ↘ 20: 9.8 → <hr/> Serie 86.0 Total 176.0	60 Skud 	21: *10.4 ↗ 22: 8.1 ↓ 23: 7.5 ← 24: 8.7 ↘ 25: 9.8 → 26: 9.9 → 27: 8.8 ↗ 28: *10.8 ↑ 29: 10.1 ↓ 30: 9.6 ← <hr/> Serie 88.0 Total 264.0
-------------	---	-------------	--

60 Skud 	31: 7.7 ← 32: *10.3 ↗ 33: 9.3 ← 34: 9.0 ↗ 35: *10.5 ↗ 36: 9.7 ↗ 37: 10.1 ← 38: 8.0 ← 39: 9.7 ← 40: *10.2 ↗ <hr/> Serie 91.0 Total 355.0	60 Skud 	41: *10.4 → 42: 9.1 ↓ 43: 8.8 ↗ 44: 7.3 ↓ 45: 7.8 ↘ 46: 8.5 ↘ 47: 7.1 ↘ 48: 8.3 ↗ 49: 8.2 ↗ 50: 9.8 ↘ <hr/> Serie 81.0 Total 436.0
-------------	--	-------------	---

60 Skud 	51: 8.0 ↑ 52: 10.0 ↓ 53: 9.1 ↑ 54: 7.9 ↓ 55: 8.8 ↘ 56: 9.8 ↘ 57: 8.5 ↘ 58: 10.0 ↗ 59: 10.1 ↗ 60: 8.5 ↗ <hr/> Serie 87.0 Total 523.0		
-------------	--	--	--

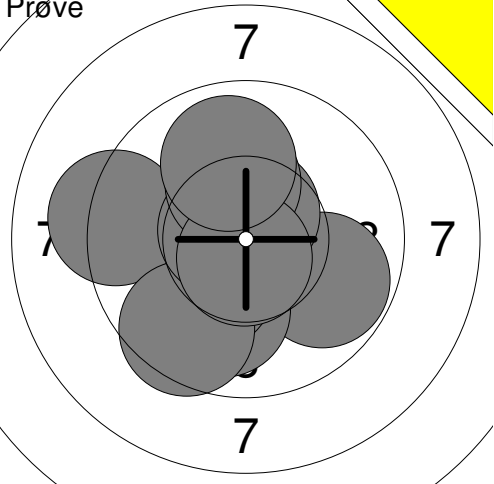
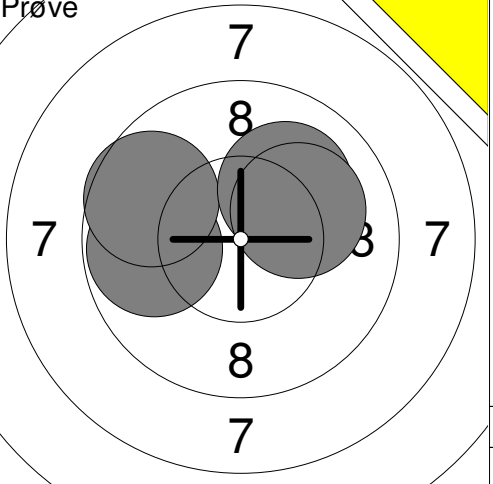
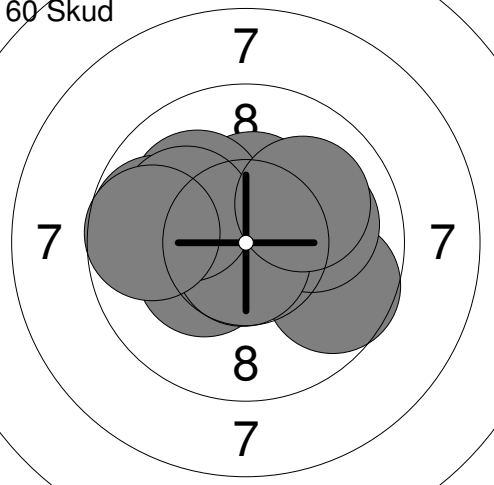
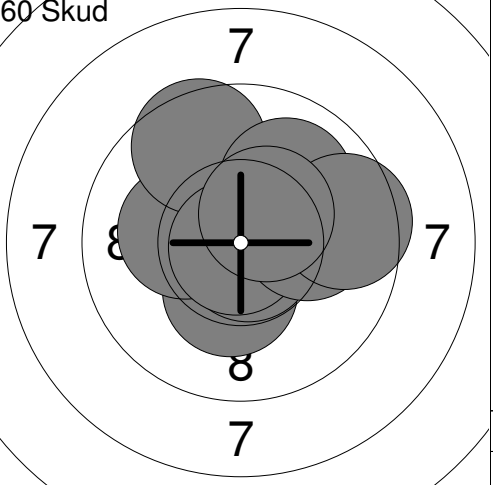
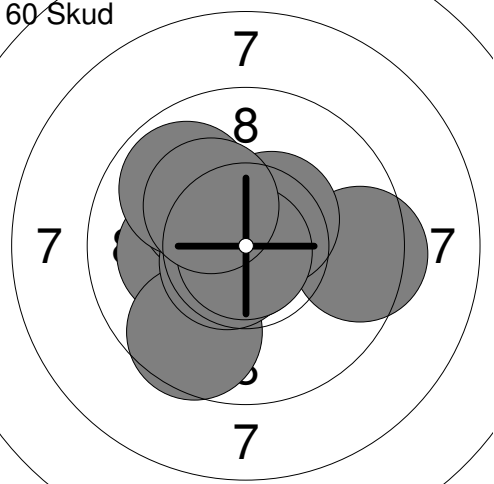
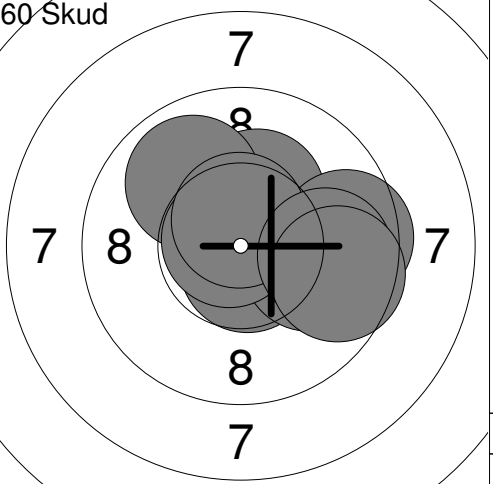
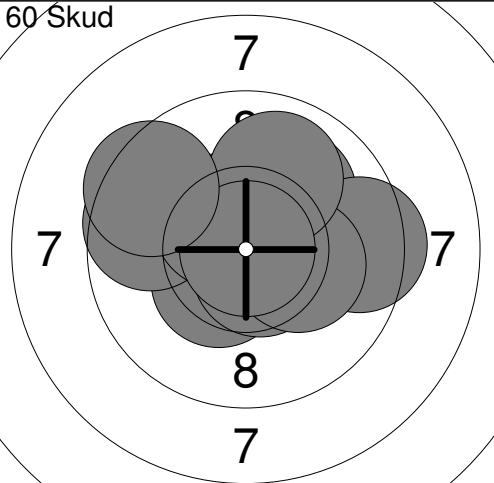
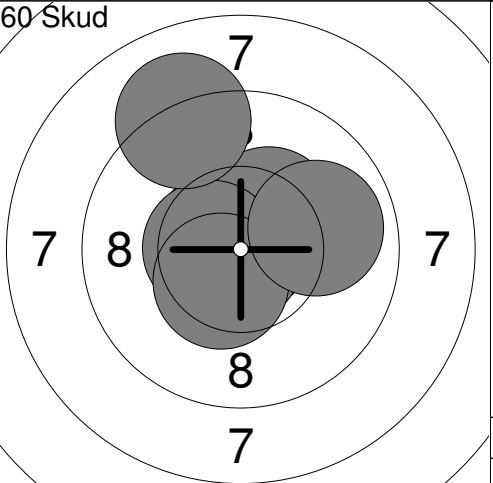
Prøve 	<table border="1" style="width:100%; border-collapse: collapse;"> <tr><td>1:</td><td>9.8</td><td>↘</td></tr> <tr><td>2:</td><td>10.0</td><td>↓</td></tr> <tr><td>3:</td><td>*10.2</td><td>↙</td></tr> <tr><td>4:</td><td>9.2</td><td>←</td></tr> <tr><td>5:</td><td>*10.6</td><td>↑</td></tr> <tr><td>6:</td><td>9.5</td><td>↘</td></tr> <tr><td>7:</td><td>*10.7</td><td>↖</td></tr> <tr><td>8:</td><td>*10.2</td><td>↑</td></tr> <tr><td>9:</td><td>*10.7</td><td>↓</td></tr> <tr><td>10:</td><td>9.9</td><td>↑</td></tr> <tr><td colspan="2">Serie</td><td style="text-align:right">96.0</td></tr> <tr><td colspan="2">Total</td><td style="text-align:right">0.0</td></tr> </table>	1:	9.8	↘	2:	10.0	↓	3:	*10.2	↙	4:	9.2	←	5:	*10.6	↑	6:	9.5	↘	7:	*10.7	↖	8:	*10.2	↑	9:	*10.7	↓	10:	9.9	↑	Serie		96.0	Total		0.0	Prøve  <table border="1" style="width:100%; border-collapse: collapse;"> <tr><td>11:</td><td>9.8</td><td>←</td></tr> <tr><td>12:</td><td>9.7</td><td>↖</td></tr> <tr><td>13:</td><td>10.1</td><td>↗</td></tr> <tr><td>14:</td><td>10.1</td><td>↘</td></tr> <tr><td colspan="2">Serie</td><td style="text-align:right">38.0</td></tr> <tr><td colspan="2">Total</td><td style="text-align:right">0.0</td></tr> </table>	11:	9.8	←	12:	9.7	↖	13:	10.1	↗	14:	10.1	↘	Serie		38.0	Total		0.0																		
1:	9.8	↘																																																																								
2:	10.0	↓																																																																								
3:	*10.2	↙																																																																								
4:	9.2	←																																																																								
5:	*10.6	↑																																																																								
6:	9.5	↘																																																																								
7:	*10.7	↖																																																																								
8:	*10.2	↑																																																																								
9:	*10.7	↓																																																																								
10:	9.9	↑																																																																								
Serie		96.0																																																																								
Total		0.0																																																																								
11:	9.8	←																																																																								
12:	9.7	↖																																																																								
13:	10.1	↗																																																																								
14:	10.1	↘																																																																								
Serie		38.0																																																																								
Total		0.0																																																																								
60 Skud 	<table border="1" style="width:100%; border-collapse: collapse;"> <tr><td>1:</td><td>9.7</td><td>↘</td></tr> <tr><td>2:</td><td>*10.4</td><td>↑</td></tr> <tr><td>3:</td><td>*10.3</td><td>↖</td></tr> <tr><td>4:</td><td>10.1</td><td>→</td></tr> <tr><td>5:</td><td>*10.7</td><td>↓</td></tr> <tr><td>6:</td><td>10.1</td><td>↗</td></tr> <tr><td>7:</td><td>9.8</td><td>←</td></tr> <tr><td>8:</td><td>10.1</td><td>↗</td></tr> <tr><td>9:</td><td>10.0</td><td>↗</td></tr> <tr><td>10:</td><td>9.7</td><td>←</td></tr> <tr><td colspan="2">Serie</td><td style="text-align:right">97.0</td></tr> <tr><td colspan="2">Total</td><td style="text-align:right">97.0</td></tr> </table>	1:	9.7	↘	2:	*10.4	↑	3:	*10.3	↖	4:	10.1	→	5:	*10.7	↓	6:	10.1	↗	7:	9.8	←	8:	10.1	↗	9:	10.0	↗	10:	9.7	←	Serie		97.0	Total		97.0	60 Skud  <table border="1" style="width:100%; border-collapse: collapse;"> <tr><td>11:</td><td>*10.3</td><td>↓</td></tr> <tr><td>12:</td><td>*10.2</td><td>←</td></tr> <tr><td>13:</td><td>*10.5</td><td>↗</td></tr> <tr><td>14:</td><td>9.6</td><td>↗</td></tr> <tr><td>15:</td><td>10.0</td><td>↗</td></tr> <tr><td>16:</td><td>*10.8</td><td>↓</td></tr> <tr><td>17:</td><td>*10.9</td><td>↙</td></tr> <tr><td>18:</td><td>10.1</td><td>→</td></tr> <tr><td>19:</td><td>9.6</td><td>→</td></tr> <tr><td>20:</td><td>*10.4</td><td>↗</td></tr> <tr><td colspan="2">Serie</td><td style="text-align:right">98.0</td></tr> <tr><td colspan="2">Total</td><td style="text-align:right">195.0</td></tr> </table>	11:	*10.3	↓	12:	*10.2	←	13:	*10.5	↗	14:	9.6	↗	15:	10.0	↗	16:	*10.8	↓	17:	*10.9	↙	18:	10.1	→	19:	9.6	→	20:	*10.4	↗	Serie		98.0	Total		195.0
1:	9.7	↘																																																																								
2:	*10.4	↑																																																																								
3:	*10.3	↖																																																																								
4:	10.1	→																																																																								
5:	*10.7	↓																																																																								
6:	10.1	↗																																																																								
7:	9.8	←																																																																								
8:	10.1	↗																																																																								
9:	10.0	↗																																																																								
10:	9.7	←																																																																								
Serie		97.0																																																																								
Total		97.0																																																																								
11:	*10.3	↓																																																																								
12:	*10.2	←																																																																								
13:	*10.5	↗																																																																								
14:	9.6	↗																																																																								
15:	10.0	↗																																																																								
16:	*10.8	↓																																																																								
17:	*10.9	↙																																																																								
18:	10.1	→																																																																								
19:	9.6	→																																																																								
20:	*10.4	↗																																																																								
Serie		98.0																																																																								
Total		195.0																																																																								
60 Skud 	<table border="1" style="width:100%; border-collapse: collapse;"> <tr><td>21:</td><td>10.1</td><td>←</td></tr> <tr><td>22:</td><td>9.4</td><td>→</td></tr> <tr><td>23:</td><td>*10.2</td><td>↗</td></tr> <tr><td>24:</td><td>9.6</td><td>↘</td></tr> <tr><td>25:</td><td>*10.5</td><td>↗</td></tr> <tr><td>26:</td><td>*10.8</td><td>↘</td></tr> <tr><td>27:</td><td>*10.6</td><td>↙</td></tr> <tr><td>28:</td><td>9.9</td><td>↗</td></tr> <tr><td>29:</td><td>*10.9</td><td>↓</td></tr> <tr><td>30:</td><td>*10.2</td><td>↗</td></tr> <tr><td colspan="2">Serie</td><td style="text-align:right">97.0</td></tr> <tr><td colspan="2">Total</td><td style="text-align:right">292.0</td></tr> </table>	21:	10.1	←	22:	9.4	→	23:	*10.2	↗	24:	9.6	↘	25:	*10.5	↗	26:	*10.8	↘	27:	*10.6	↙	28:	9.9	↗	29:	*10.9	↓	30:	*10.2	↗	Serie		97.0	Total		292.0	60 Skud  <table border="1" style="width:100%; border-collapse: collapse;"> <tr><td>31:</td><td>*10.7</td><td>↘</td></tr> <tr><td>32:</td><td>*10.7</td><td>↓</td></tr> <tr><td>33:</td><td>10.0</td><td>→</td></tr> <tr><td>34:</td><td>*10.3</td><td>↑</td></tr> <tr><td>35:</td><td>9.9</td><td>↗</td></tr> <tr><td>36:</td><td>*10.8</td><td>↗</td></tr> <tr><td>37:</td><td>9.6</td><td>→</td></tr> <tr><td>38:</td><td>*10.6</td><td>↑</td></tr> <tr><td>39:</td><td>9.8</td><td>→</td></tr> <tr><td>40:</td><td>9.6</td><td>→</td></tr> <tr><td colspan="2">Serie</td><td style="text-align:right">96.0</td></tr> <tr><td colspan="2">Total</td><td style="text-align:right">388.0</td></tr> </table>	31:	*10.7	↘	32:	*10.7	↓	33:	10.0	→	34:	*10.3	↑	35:	9.9	↗	36:	*10.8	↗	37:	9.6	→	38:	*10.6	↑	39:	9.8	→	40:	9.6	→	Serie		96.0	Total		388.0
21:	10.1	←																																																																								
22:	9.4	→																																																																								
23:	*10.2	↗																																																																								
24:	9.6	↘																																																																								
25:	*10.5	↗																																																																								
26:	*10.8	↘																																																																								
27:	*10.6	↙																																																																								
28:	9.9	↗																																																																								
29:	*10.9	↓																																																																								
30:	*10.2	↗																																																																								
Serie		97.0																																																																								
Total		292.0																																																																								
31:	*10.7	↘																																																																								
32:	*10.7	↓																																																																								
33:	10.0	→																																																																								
34:	*10.3	↑																																																																								
35:	9.9	↗																																																																								
36:	*10.8	↗																																																																								
37:	9.6	→																																																																								
38:	*10.6	↑																																																																								
39:	9.8	→																																																																								
40:	9.6	→																																																																								
Serie		96.0																																																																								
Total		388.0																																																																								
60 Skud 	<table border="1" style="width:100%; border-collapse: collapse;"> <tr><td>41:</td><td>*10.4</td><td>↙</td></tr> <tr><td>42:</td><td>10.0</td><td>↗</td></tr> <tr><td>43:</td><td>9.4</td><td>→</td></tr> <tr><td>44:</td><td>9.6</td><td>←</td></tr> <tr><td>45:</td><td>*10.5</td><td>↗</td></tr> <tr><td>46:</td><td>*10.6</td><td>↘</td></tr> <tr><td>47:</td><td>*10.2</td><td>→</td></tr> <tr><td>48:</td><td>9.9</td><td>↑</td></tr> <tr><td>49:</td><td>*10.9</td><td>→</td></tr> <tr><td>50:</td><td>9.5</td><td>↗</td></tr> <tr><td colspan="2">Serie</td><td style="text-align:right">96.0</td></tr> <tr><td colspan="2">Total</td><td style="text-align:right">484.0</td></tr> </table>	41:	*10.4	↙	42:	10.0	↗	43:	9.4	→	44:	9.6	←	45:	*10.5	↗	46:	*10.6	↘	47:	*10.2	→	48:	9.9	↑	49:	*10.9	→	50:	9.5	↗	Serie		96.0	Total		484.0	60 Skud  <table border="1" style="width:100%; border-collapse: collapse;"> <tr><td>51:</td><td>*10.9</td><td>↗</td></tr> <tr><td>52:</td><td>*10.7</td><td>↑</td></tr> <tr><td>53:</td><td>*10.7</td><td>↖</td></tr> <tr><td>54:</td><td>*10.8</td><td>↗</td></tr> <tr><td>55:</td><td>*10.8</td><td>↘</td></tr> <tr><td>56:</td><td>*10.4</td><td>↗</td></tr> <tr><td>57:</td><td>*10.5</td><td>←</td></tr> <tr><td>58:</td><td>*10.5</td><td>↘</td></tr> <tr><td>59:</td><td>9.9</td><td>→</td></tr> <tr><td>60:</td><td>9.1</td><td>↗</td></tr> <tr><td colspan="2">Serie</td><td style="text-align:right">98.0</td></tr> <tr><td colspan="2">Total</td><td style="text-align:right">582.0</td></tr> </table>	51:	*10.9	↗	52:	*10.7	↑	53:	*10.7	↖	54:	*10.8	↗	55:	*10.8	↘	56:	*10.4	↗	57:	*10.5	←	58:	*10.5	↘	59:	9.9	→	60:	9.1	↗	Serie		98.0	Total		582.0
41:	*10.4	↙																																																																								
42:	10.0	↗																																																																								
43:	9.4	→																																																																								
44:	9.6	←																																																																								
45:	*10.5	↗																																																																								
46:	*10.6	↘																																																																								
47:	*10.2	→																																																																								
48:	9.9	↑																																																																								
49:	*10.9	→																																																																								
50:	9.5	↗																																																																								
Serie		96.0																																																																								
Total		484.0																																																																								
51:	*10.9	↗																																																																								
52:	*10.7	↑																																																																								
53:	*10.7	↖																																																																								
54:	*10.8	↗																																																																								
55:	*10.8	↘																																																																								
56:	*10.4	↗																																																																								
57:	*10.5	←																																																																								
58:	*10.5	↘																																																																								
59:	9.9	→																																																																								
60:	9.1	↗																																																																								
Serie		98.0																																																																								
Total		582.0																																																																								

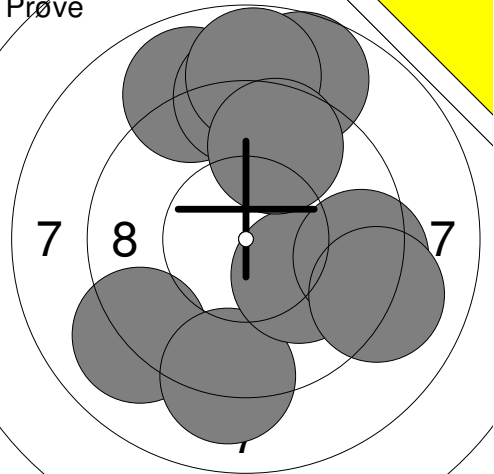
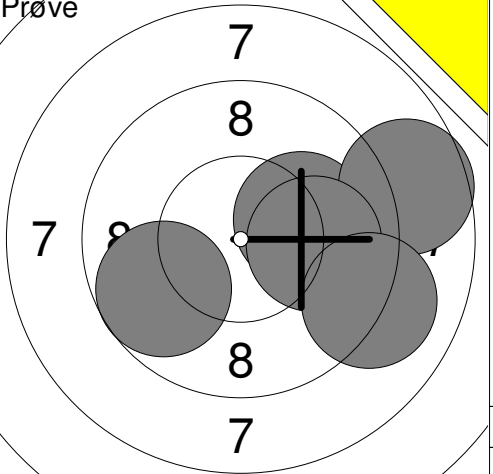
<p>Prøve</p> 	<p>1: 8.9 ↗ 2: 9.1 ↑ 3: 9.1 ↙ 4: 9.1 ↓ 5: 8.7 ↗ 6: 10.1 ↘ 7: 9.4 → 8: 8.8 ↑ 9: 9.7 ↑ 10: 9.1 ↘</p> <p>Serie 88.0 Total 0.0</p>	<p>Prøve</p> 	<p>11: 10.1 → 12: 8.7 → 13: 10.0 → 14: 9.1 ↘ 15: 9.7 ↙</p> <p>Serie 46.0 Total 0.0</p>
---	--	---	--

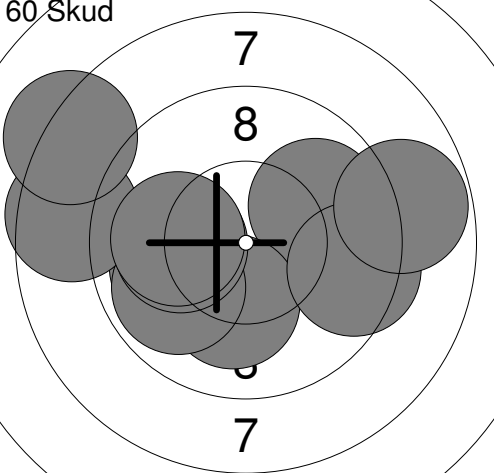
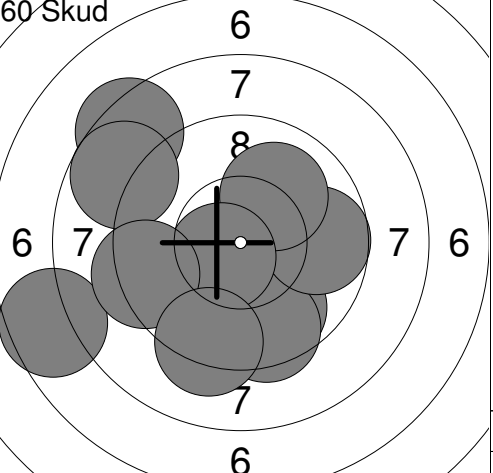
<p>60 Skud</p> 	<p>1: 9.9 → 2: 10.0 ← 3: 10.1 ↓ 4: 9.5 → 5: 9.9 ← 6: 8.6 ← 7: 8.2 ↗ 8: 8.8 → 9: 10.1 ← 10: 10.0 ←</p> <p>Serie 91.0 Total 91.0</p>	<p>60 Skud</p> 	<p>11: 8.4 ↖ 12: 9.8 ↓ 13: 7.6 ← 14: 9.5 ↓ 15: 9.7 → 16: 10.0 ↗ 17: *10.6 ← 18: 8.7 ↖ 19: 9.3 ← 20: 9.2 ↓</p> <p>Serie 88.0 Total 179.0</p>
--	--	--	---

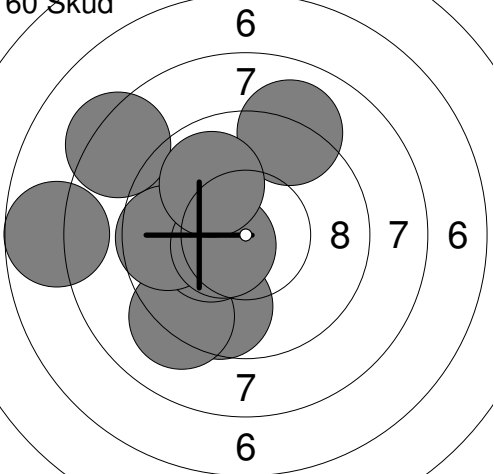
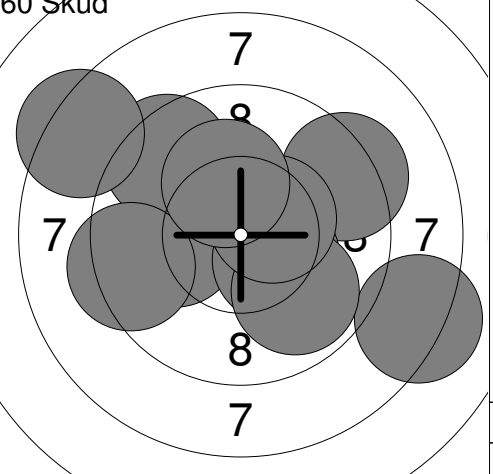
<p>60 Skud</p> 	<p>21: 9.1 ↗ 22: 9.7 ↓ 23: 9.2 ↘ 24: 9.9 ↗ 25: *10.3 ← 26: 7.7 ← 27: 9.6 ← 28: *10.5 ← 29: 8.3 ↗ 30: 9.9 ↗</p> <p>Serie 89.0 Total 268.0</p>	<p>60 Skud</p> 	<p>31: 9.3 ↗ 32: 10.0 ← 33: *10.3 ↘ 34: 8.2 ↘ 35: 9.5 ↗ 36: 9.9 ↓ 37: 8.3 ↗ 38: *10.5 ↗ 39: 9.4 ← 40: *10.2 ↑</p> <p>Serie 92.0 Total 360.0</p>
---	--	---	---

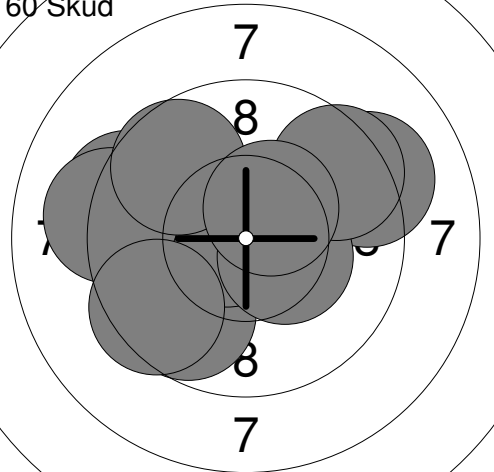
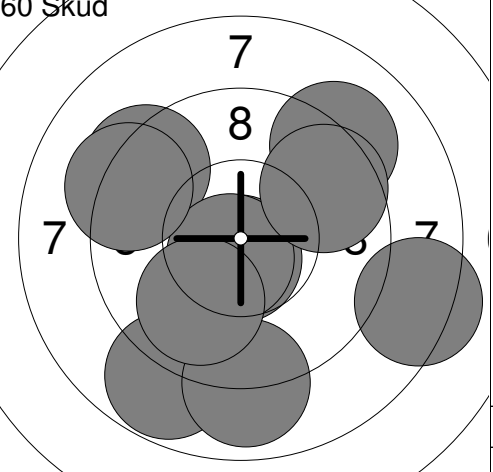
<p>60 Skud</p> 	<p>41: 9.7 ↓ 42: 9.3 ← 43: *10.7 ← 44: 9.1 ← 45: 9.7 ↗ 46: 9.2 → 47: *10.4 ↘ 48: 9.5 ← 49: 9.5 ↗ 50: *10.4 ↗</p> <p>Serie 93.0 Total 453.0</p>	<p>60 Skud</p> 	<p>51: 9.3 ↖ 52: 9.1 ↗ 53: *10.7 ↓ 54: *10.6 ↓ 55: 8.8 ↓ 56: 8.3 → 57: 8.9 ↓ 58: 9.6 ↗ 59: 9.2 ↖ 60: 9.9 ↓</p> <p>Serie 89.0 Total 542.0</p>
---	--	---	--

Prøve 	1: 9.1 2: 9.0 3: 8.7 4: 9.3 5: 9.7 6: 8.5 7: *10.2 8: 9.2 9: 9.8 10: *10.6 Serie 90.0 Total 0.0	Prøve 	11: *10.7 12: 8.7 13: *10.5 14: 9.7 15: 9.8 16: *10.6 17: 9.7 18: 9.7 19: 10.1 20: 9.2 Serie 93.0 Total 0.0
------------------	--	------------------	--

Prøve 	21: *10.8 Serie 10.0 Total 0.0	60 Skud 	1: 8.1 2: 9.9 3: 10.0 4: 9.9 5: 9.8 6: *10.4 7: 9.7 8: *10.5 9: 10.0 10: 8.8 Serie 92.0 Total 92.0
------------------	--------------------------------------	--------------------	---

60 Skud 	11: *10.2 12: *10.5 13: *10.2 14: *10.3 15: *10.8 16: *10.7 17: 9.9 18: 10.1 19: 10.0 20: 9.7 Serie 98.0 Total 190.0	60 Skud 	21: 9.1 22: *10.5 23: *10.2 24: 9.9 25: *10.6 26: *10.3 27: *10.4 28: 9.5 29: *10.6 30: 9.7 Serie 96.0 Total 286.0
--------------------	---	--------------------	---

60 Skud 	31: 10.0 32: 9.7 33: *10.6 34: *10.2 35: 10.0 36: *10.6 37: *10.4 38: 10.0 39: *10.5 40: *10.2 Serie 99.0 Total 385.0	60 Skud 	41: *10.4 42: *10.3 43: 9.6 44: 8.9 45: 9.7 46: 9.2 47: 9.8 48: 9.7 49: *10.2 50: *10.6 Serie 93.0 Total 478.0
--------------------	--	--------------------	---

60 Skud 	51: 9.9 52: 9.7 53: 9.8 54: 9.4 55: *10.8 56: 9.7 57: *10.6 58: *10.7 59: *10.2 60: *10.5 Serie 95.0 Total 573.0		
--------------------	---	--	--

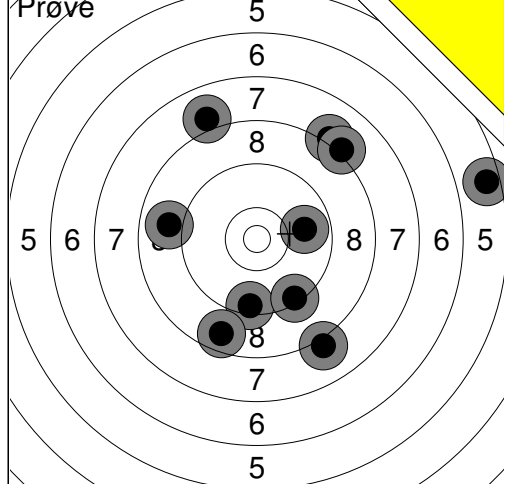

1:	9.4	↓
2:	8.9	←
3:	8.6	↓
4:	8.1	↓
5:	9.8	→
6:	9.4	↓
7:	8.1	↗
8:	8.1	↗
9:	5.5	→
10:	8.0	↖
Serie		80.0
Total		0.0

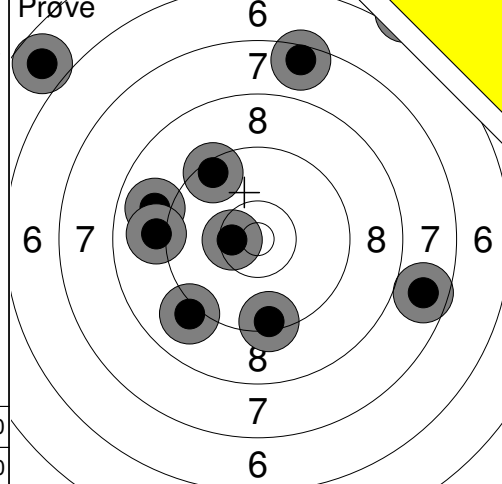

11:	5.8	↖
12:	8.9	←
13:	*10.5	←
14:	7.5	↑
15:	9.5	↗
16:	7.7	→
17:	5.9	↗
18:	9.0	←
19:	9.1	↙
20:	9.4	↓
Serie		78.0
Total		0.0

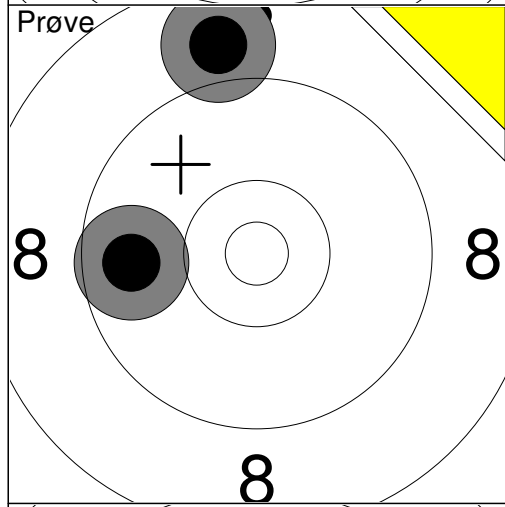

21:	9.7	←
22:	8.9	↑
Serie		17.0
Total		0.0

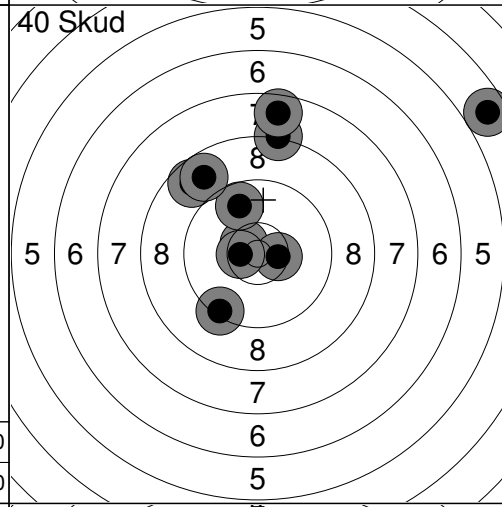

1:	*10.6	↖
2:	4.7	↗
3:	8.7	↗
4:	9.8	↑
5:	*10.5	→
6:	8.2	↑
7:	8.8	↗
8:	7.7	↑
9:	*10.5	←
10:	9.4	↙
Serie		83.0
Total		83.0

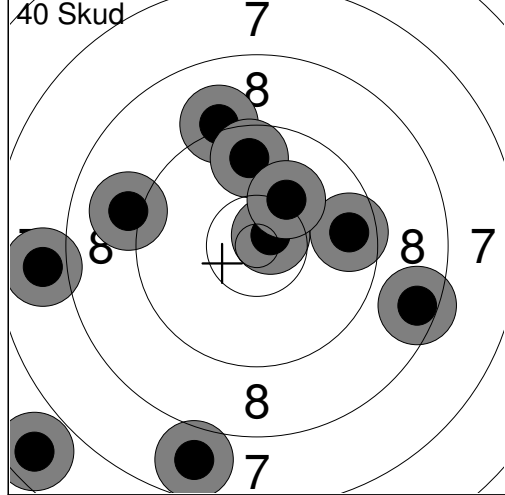

11:	8.5	→
12:	*10.7	↗
13:	9.1	↑
14:	7.9	←
15:	9.7	↑
16:	9.6	→
17:	9.1	←
18:	6.6	↙
19:	7.8	↓
20:	10.2	↗
Serie		84.0
Total		167.0

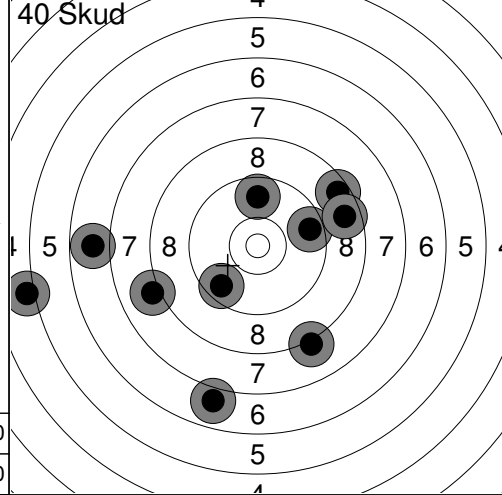

21:	8.1	←
22:	6.8	←
23:	9.6	↙
24:	5.0	←
25:	9.6	→
26:	9.7	↑
27:	8.5	↗
28:	8.6	→
29:	6.9	↓
30:	8.1	↙
Serie		76.0
Total		243.0

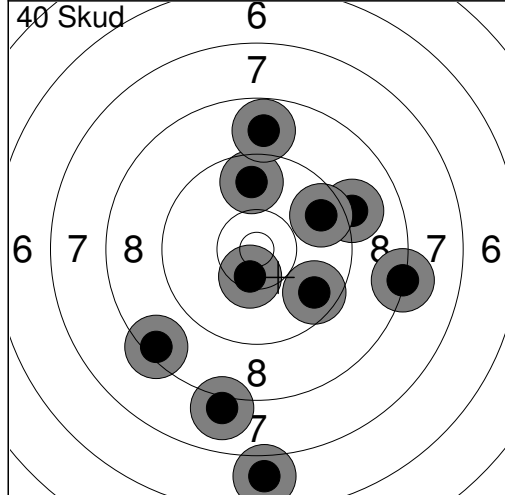

31:	8.3	→
32:	8.4	↙
33:	9.7	↑
34:	6.9	↓
35:	8.0	↓
36:	*10.4	↓
37:	9.7	↙
38:	9.1	→
39:	8.8	↑
40:	9.6	↗
Serie		84.0
Total		327.0

<p>Prøve</p>	<p>1: 8.9 ↓</p> <p>2: 8.5 ↘</p> <p>3: 9.0 ↗</p> <p>4: 9.5 →</p> <p>5: 8.7 ↘</p> <p>6: 7.6 ↗</p> <p>7: 8.1 ↘</p> <p>8: 9.7 ←</p> <p>9: 8.7 ←</p> <p>10: 9.2 ↓</p>	<p>Prøve</p>	<p>11: 9.3 ↓</p> <p>12: 8.9 ←</p> <p>13: 9.6 ↗</p>
Serie	83.0	Serie	26.0
Total	0.0	Total	0.0

<p>40 Skud</p>	<p>1: *10.6 →</p> <p>2: 6.7 ↓</p> <p>3: 8.6 ↓</p> <p>4: 9.1 ←</p> <p>5: 6.1 ↓</p> <p>6: 8.5 ↓</p> <p>7: 9.4 ←</p> <p>8: 9.1 ↓</p> <p>9: 8.1 ←</p> <p>10: 8.3 ↓</p>	<p>40 Skud</p>	<p>11: 8.3 ↗</p> <p>12: *10.4 ↖</p> <p>13: 9.8 ↓</p> <p>14: 7.9 ↓</p> <p>15: 8.5 ↓</p> <p>16: 9.3 →</p> <p>17: *10.8 ↘</p> <p>18: 10.2 ↗</p> <p>19: 7.7 ←</p> <p>20: 10.1 ↗</p>
Serie	81.0	Serie	88.0
Total	81.0	Total	169.0

<p>40 Skud</p>	<p>21: 9.4 ↗</p> <p>22: 9.9 ←</p> <p>23: 9.8 ↓</p> <p>24: 6.8 ←</p> <p>25: 9.2 ←</p> <p>26: 9.3 ↗</p> <p>27: 10.2 ↓</p> <p>28: 9.2 ↗</p> <p>29: 7.0 ↓</p> <p>30: 8.3 ↗</p>	<p>40 Skud</p>	<p>31: 9.3 ←</p> <p>32: 8.3 ←</p> <p>33: 9.4 ↗</p> <p>34: 9.8 ↖</p> <p>35: 8.7 ↓</p> <p>36: 9.0 ↗</p> <p>37: 9.6 ↓</p> <p>38: 9.1 →</p> <p>39: 8.8 →</p> <p>40: 9.9 ↗</p>
Serie	85.0	Serie	87.0
Total	254.0	Total	341.0

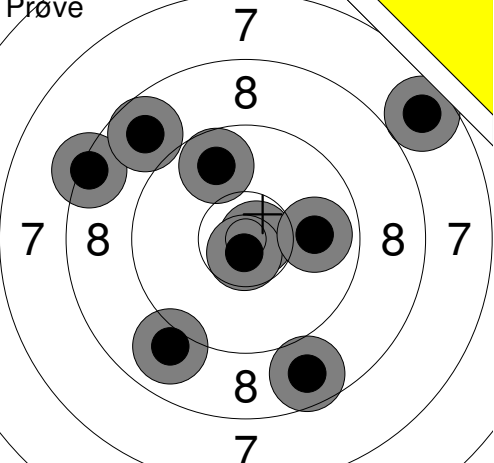
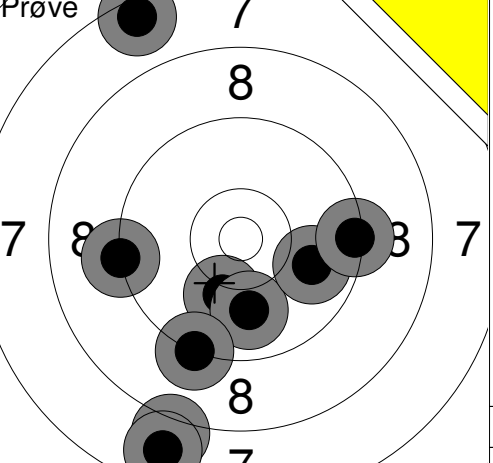
<p>Prøve</p> 	<table style="width:100%; border-collapse: collapse;"> <tr><td>1:</td><td>9.0</td><td>↘</td></tr> <tr><td>2:</td><td>9.8</td><td>↗</td></tr> <tr><td>3:</td><td>8.4</td><td>↖</td></tr> <tr><td>4:</td><td>*10.8</td><td>→</td></tr> <tr><td>5:</td><td>8.8</td><td>↗</td></tr> <tr><td>6:</td><td>*10.7</td><td>↘</td></tr> <tr><td>7:</td><td>6.5</td><td>↗</td></tr> <tr><td>8:</td><td>9.9</td><td>→</td></tr> <tr><td>9:</td><td>8.7</td><td>↘</td></tr> <tr><td>10:</td><td>7.7</td><td>↗</td></tr> <tr><td colspan="2">Serie</td><td>84.0</td></tr> <tr><td colspan="2">Total</td><td>0.0</td></tr> </table>	1:	9.0	↘	2:	9.8	↗	3:	8.4	↖	4:	*10.8	→	5:	8.8	↗	6:	*10.7	↘	7:	6.5	↗	8:	9.9	→	9:	8.7	↘	10:	7.7	↗	Serie		84.0	Total		0.0	<p>Prøve</p>  <table style="width:100%; border-collapse: collapse;"> <tr><td>11:</td><td>10.1</td><td>↘</td></tr> <tr><td>12:</td><td>9.9</td><td>↘</td></tr> <tr><td>13:</td><td>9.2</td><td>↘</td></tr> <tr><td>14:</td><td>9.2</td><td>←</td></tr> <tr><td>15:</td><td>9.9</td><td>→</td></tr> <tr><td>16:</td><td>8.0</td><td>↘</td></tr> <tr><td>17:</td><td>9.3</td><td>→</td></tr> <tr><td>18:</td><td>7.5</td><td>↗</td></tr> <tr><td>19:</td><td>7.8</td><td>↘</td></tr> <tr><td colspan="2">Serie</td><td>77.0</td></tr> <tr><td colspan="2">Total</td><td>0.0</td></tr> </table>	11:	10.1	↘	12:	9.9	↘	13:	9.2	↘	14:	9.2	←	15:	9.9	→	16:	8.0	↘	17:	9.3	→	18:	7.5	↗	19:	7.8	↘	Serie		77.0	Total		0.0
1:	9.0	↘																																																																					
2:	9.8	↗																																																																					
3:	8.4	↖																																																																					
4:	*10.8	→																																																																					
5:	8.8	↗																																																																					
6:	*10.7	↘																																																																					
7:	6.5	↗																																																																					
8:	9.9	→																																																																					
9:	8.7	↘																																																																					
10:	7.7	↗																																																																					
Serie		84.0																																																																					
Total		0.0																																																																					
11:	10.1	↘																																																																					
12:	9.9	↘																																																																					
13:	9.2	↘																																																																					
14:	9.2	←																																																																					
15:	9.9	→																																																																					
16:	8.0	↘																																																																					
17:	9.3	→																																																																					
18:	7.5	↗																																																																					
19:	7.8	↘																																																																					
Serie		77.0																																																																					
Total		0.0																																																																					

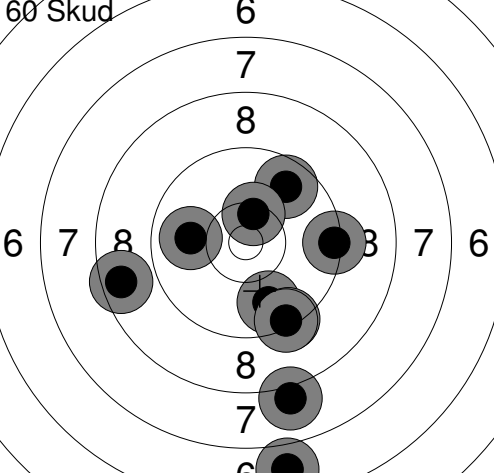
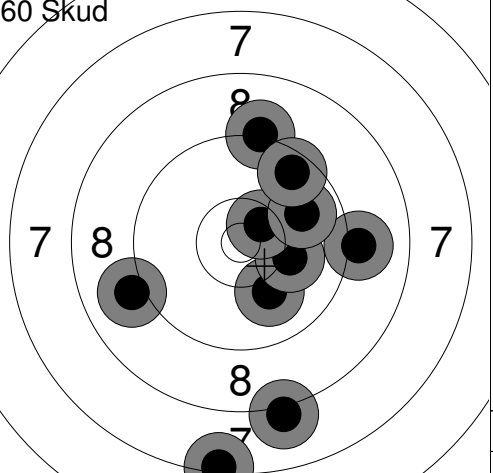
<p>60 Skud</p>  <table style="width:100%; border-collapse: collapse;"> <tr><td>1:</td><td>9.8</td><td>↘</td></tr> <tr><td>2:</td><td>8.6</td><td>←</td></tr> <tr><td>3:</td><td>9.7</td><td>↗</td></tr> <tr><td>4:</td><td>8.0</td><td>↘</td></tr> <tr><td>5:</td><td>9.3</td><td>→</td></tr> <tr><td>6:</td><td>9.4</td><td>↘</td></tr> <tr><td>7:</td><td>9.4</td><td>↘</td></tr> <tr><td>8:</td><td>*10.4</td><td>↗</td></tr> <tr><td>9:</td><td>10.0</td><td>←</td></tr> <tr><td>10:</td><td>6.8</td><td>↘</td></tr> <tr><td colspan="2">Serie</td><td>87.0</td></tr> <tr><td colspan="2">Total</td><td>87.0</td></tr> </table>	1:	9.8	↘	2:	8.6	←	3:	9.7	↗	4:	8.0	↘	5:	9.3	→	6:	9.4	↘	7:	9.4	↘	8:	*10.4	↗	9:	10.0	←	10:	6.8	↘	Serie		87.0	Total		87.0	<p>60 Skud</p>  <table style="width:100%; border-collapse: collapse;"> <tr><td>11:</td><td>10.0</td><td>↘</td></tr> <tr><td>12:</td><td>10.1</td><td>→</td></tr> <tr><td>13:</td><td>9.1</td><td>→</td></tr> <tr><td>14:</td><td>7.3</td><td>↘</td></tr> <tr><td>15:</td><td>*10.5</td><td>↗</td></tr> <tr><td>16:</td><td>9.9</td><td>↗</td></tr> <tr><td>17:</td><td>9.2</td><td>↑</td></tr> <tr><td>18:</td><td>9.5</td><td>↗</td></tr> <tr><td>19:</td><td>9.0</td><td>←</td></tr> <tr><td>20:</td><td>8.1</td><td>↘</td></tr> <tr><td colspan="2">Serie</td><td>90.0</td></tr> <tr><td colspan="2">Total</td><td>177.0</td></tr> </table>	11:	10.0	↘	12:	10.1	→	13:	9.1	→	14:	7.3	↘	15:	*10.5	↗	16:	9.9	↗	17:	9.2	↑	18:	9.5	↗	19:	9.0	←	20:	8.1	↘	Serie		90.0	Total		177.0
1:	9.8	↘																																																																							
2:	8.6	←																																																																							
3:	9.7	↗																																																																							
4:	8.0	↘																																																																							
5:	9.3	→																																																																							
6:	9.4	↘																																																																							
7:	9.4	↘																																																																							
8:	*10.4	↗																																																																							
9:	10.0	←																																																																							
10:	6.8	↘																																																																							
Serie		87.0																																																																							
Total		87.0																																																																							
11:	10.0	↘																																																																							
12:	10.1	→																																																																							
13:	9.1	→																																																																							
14:	7.3	↘																																																																							
15:	*10.5	↗																																																																							
16:	9.9	↗																																																																							
17:	9.2	↑																																																																							
18:	9.5	↗																																																																							
19:	9.0	←																																																																							
20:	8.1	↘																																																																							
Serie		90.0																																																																							
Total		177.0																																																																							

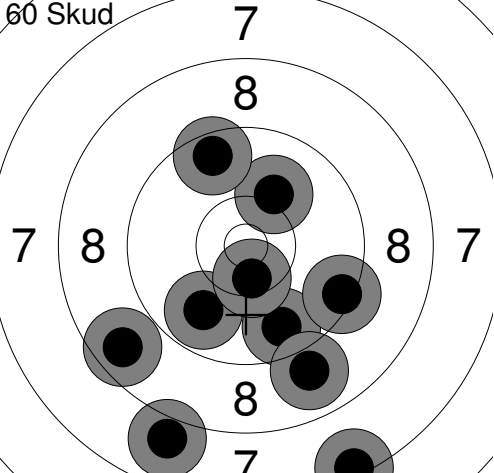
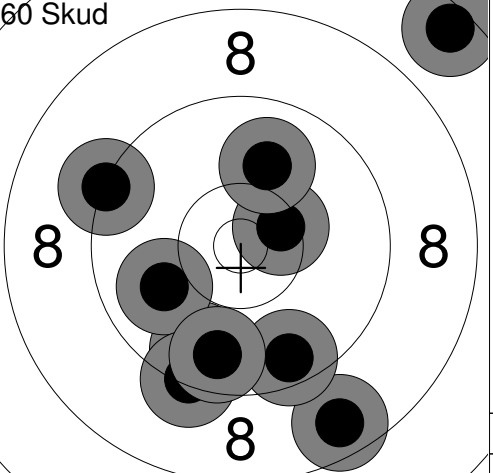
<p>60 Skud</p>  <table style="width:100%; border-collapse: collapse;"> <tr><td>21:</td><td>9.7</td><td>↘</td></tr> <tr><td>22:</td><td>7.4</td><td>↘</td></tr> <tr><td>23:</td><td>7.9</td><td>↘</td></tr> <tr><td>24:</td><td>10.1</td><td>↗</td></tr> <tr><td>25:</td><td>8.6</td><td>←</td></tr> <tr><td>26:</td><td>9.6</td><td>↗</td></tr> <tr><td>27:</td><td>9.8</td><td>↘</td></tr> <tr><td>28:</td><td>8.9</td><td>↘</td></tr> <tr><td>29:</td><td>9.4</td><td>→</td></tr> <tr><td>30:</td><td>*10.5</td><td>↘</td></tr> <tr><td colspan="2">Serie</td><td>86.0</td></tr> <tr><td colspan="2">Total</td><td>263.0</td></tr> </table>	21:	9.7	↘	22:	7.4	↘	23:	7.9	↘	24:	10.1	↗	25:	8.6	←	26:	9.6	↗	27:	9.8	↘	28:	8.9	↘	29:	9.4	→	30:	*10.5	↘	Serie		86.0	Total		263.0	<p>60 Skud</p>  <table style="width:100%; border-collapse: collapse;"> <tr><td>31:</td><td>7.5</td><td>↗</td></tr> <tr><td>32:</td><td>8.6</td><td>↘</td></tr> <tr><td>33:</td><td>9.7</td><td>↘</td></tr> <tr><td>34:</td><td>*10.4</td><td>↗</td></tr> <tr><td>35:</td><td>10.0</td><td>←</td></tr> <tr><td>36:</td><td>10.0</td><td>↑</td></tr> <tr><td>37:</td><td>9.3</td><td>←</td></tr> <tr><td>38:</td><td>9.3</td><td>↘</td></tr> <tr><td>39:</td><td>9.5</td><td>↘</td></tr> <tr><td>40:</td><td>9.7</td><td>↘</td></tr> <tr><td colspan="2">Serie</td><td>90.0</td></tr> <tr><td colspan="2">Total</td><td>353.0</td></tr> </table>	31:	7.5	↗	32:	8.6	↘	33:	9.7	↘	34:	*10.4	↗	35:	10.0	←	36:	10.0	↑	37:	9.3	←	38:	9.3	↘	39:	9.5	↘	40:	9.7	↘	Serie		90.0	Total		353.0
21:	9.7	↘																																																																							
22:	7.4	↘																																																																							
23:	7.9	↘																																																																							
24:	10.1	↗																																																																							
25:	8.6	←																																																																							
26:	9.6	↗																																																																							
27:	9.8	↘																																																																							
28:	8.9	↘																																																																							
29:	9.4	→																																																																							
30:	*10.5	↘																																																																							
Serie		86.0																																																																							
Total		263.0																																																																							
31:	7.5	↗																																																																							
32:	8.6	↘																																																																							
33:	9.7	↘																																																																							
34:	*10.4	↗																																																																							
35:	10.0	←																																																																							
36:	10.0	↑																																																																							
37:	9.3	←																																																																							
38:	9.3	↘																																																																							
39:	9.5	↘																																																																							
40:	9.7	↘																																																																							
Serie		90.0																																																																							
Total		353.0																																																																							

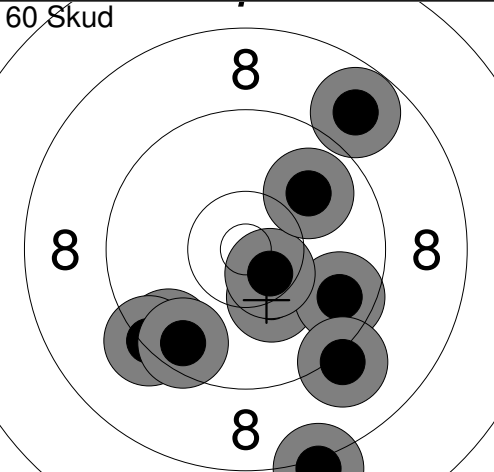
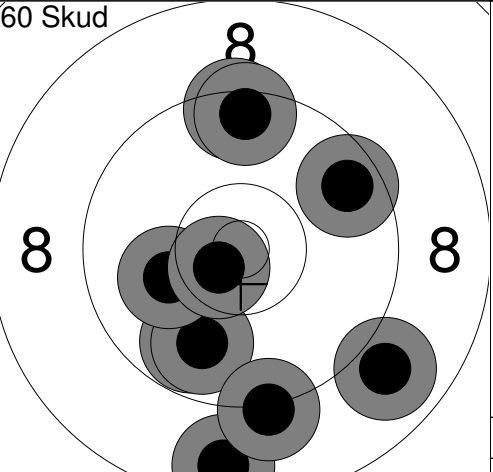
<p>60 Skud</p>  <table style="width:100%; border-collapse: collapse;"> <tr><td>41:</td><td>8.8</td><td>↗</td></tr> <tr><td>42:</td><td>10.3</td><td>↘</td></tr> <tr><td>43:</td><td>9.7</td><td>↘</td></tr> <tr><td>44:</td><td>9.5</td><td>↘</td></tr> <tr><td>45:</td><td>*10.5</td><td>↘</td></tr> <tr><td>46:</td><td>9.9</td><td>↗</td></tr> <tr><td>47:</td><td>9.3</td><td>↘</td></tr> <tr><td>48:</td><td>9.6</td><td>↘</td></tr> <tr><td>49:</td><td>9.1</td><td>↘</td></tr> <tr><td>50:</td><td>8.1</td><td>↘</td></tr> <tr><td colspan="2">Serie</td><td>90.0</td></tr> <tr><td colspan="2">Total</td><td>443.0</td></tr> </table>	41:	8.8	↗	42:	10.3	↘	43:	9.7	↘	44:	9.5	↘	45:	*10.5	↘	46:	9.9	↗	47:	9.3	↘	48:	9.6	↘	49:	9.1	↘	50:	8.1	↘	Serie		90.0	Total		443.0	<p>60 Skud</p>  <table style="width:100%; border-collapse: collapse;"> <tr><td>51:</td><td>9.4</td><td>↑</td></tr> <tr><td>52:</td><td>8.6</td><td>↘</td></tr> <tr><td>53:</td><td>9.8</td><td>↘</td></tr> <tr><td>54:</td><td>9.8</td><td>↘</td></tr> <tr><td>55:</td><td>9.2</td><td>↘</td></tr> <tr><td>56:</td><td>8.9</td><td>↘</td></tr> <tr><td>57:</td><td>10.1</td><td>←</td></tr> <tr><td>58:</td><td>9.6</td><td>↗</td></tr> <tr><td>59:</td><td>9.5</td><td>↑</td></tr> <tr><td>60:</td><td>*10.6</td><td>←</td></tr> <tr><td colspan="2">Serie</td><td>90.0</td></tr> <tr><td colspan="2">Total</td><td>533.0</td></tr> </table>	51:	9.4	↑	52:	8.6	↘	53:	9.8	↘	54:	9.8	↘	55:	9.2	↘	56:	8.9	↘	57:	10.1	←	58:	9.6	↗	59:	9.5	↑	60:	*10.6	←	Serie		90.0	Total		533.0
41:	8.8	↗																																																																							
42:	10.3	↘																																																																							
43:	9.7	↘																																																																							
44:	9.5	↘																																																																							
45:	*10.5	↘																																																																							
46:	9.9	↗																																																																							
47:	9.3	↘																																																																							
48:	9.6	↘																																																																							
49:	9.1	↘																																																																							
50:	8.1	↘																																																																							
Serie		90.0																																																																							
Total		443.0																																																																							
51:	9.4	↑																																																																							
52:	8.6	↘																																																																							
53:	9.8	↘																																																																							
54:	9.8	↘																																																																							
55:	9.2	↘																																																																							
56:	8.9	↘																																																																							
57:	10.1	←																																																																							
58:	9.6	↗																																																																							
59:	9.5	↑																																																																							
60:	*10.6	←																																																																							
Serie		90.0																																																																							
Total		533.0																																																																							

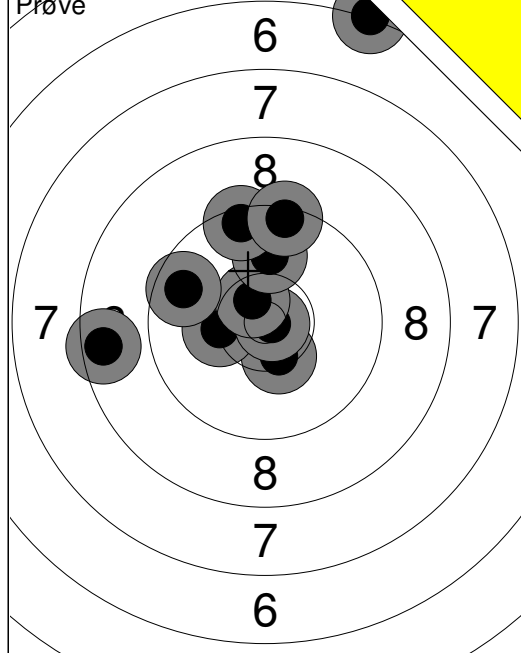

1: *10.4	↓
2: 10.3	←
3: *10.9	→
4: *10.6	↖
5: 10.0	↑
6: 9.5	↑
7: 9.4	↑
8: 6.2	↑
9: 9.7	←
10: 8.5	←
Serie 91.0	
Total 0.0	

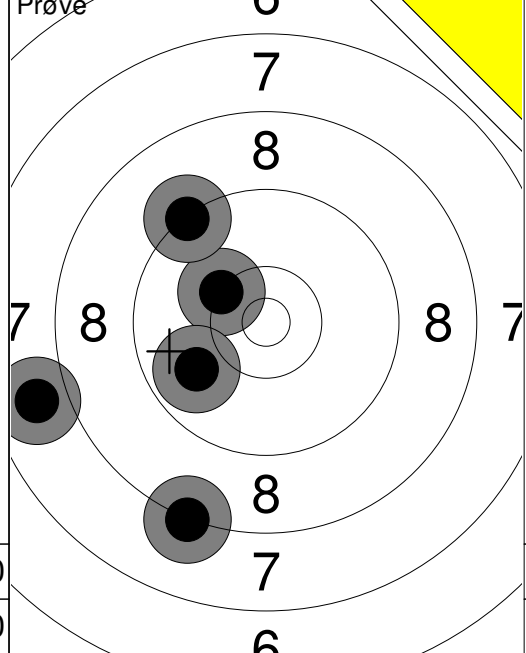

11: 10.3	↖
12: 9.9	↙
13: 9.3	↗
14: 7.8	↙
15: 8.2	↓
Serie 43.0	
Total 0.0	

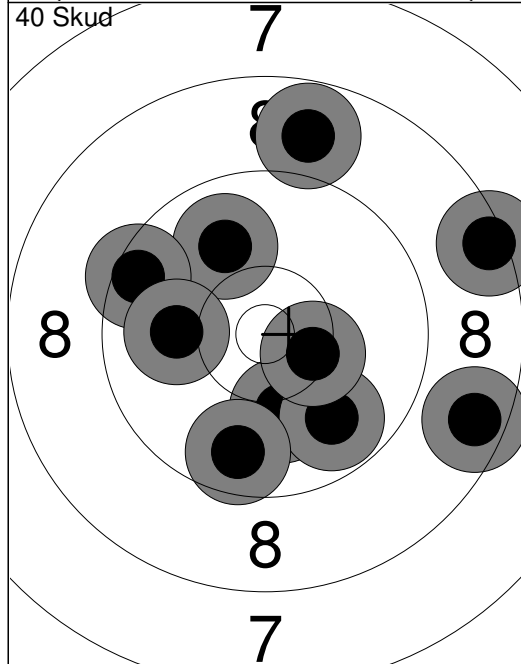

1: 10.1	↓
2: 9.9	↑
3: 9.5	←
4: 10.0	←
5: 9.8	↓
6: 8.6	→
7: *10.4	→
8: 8.4	→
9: 9.7	↓
10: 8.8	↑
Serie 90.0	
Total 90.0	

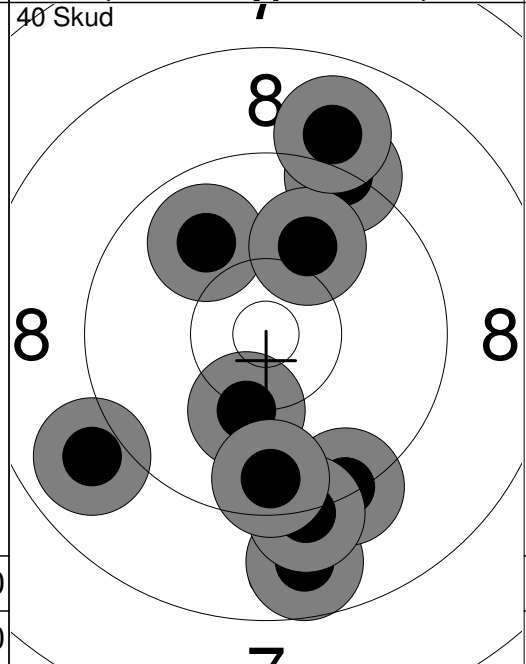

11: 9.3	↗
12: 9.9	↖
13: 8.9	↙
14: 8.8	↓
15: 9.3	↓
16: 10.2	↓
17: 9.2	↓
18: 9.6	↓
19: 10.0	↑
20: 9.0	↑
Serie 90.0	
Total 180.0	

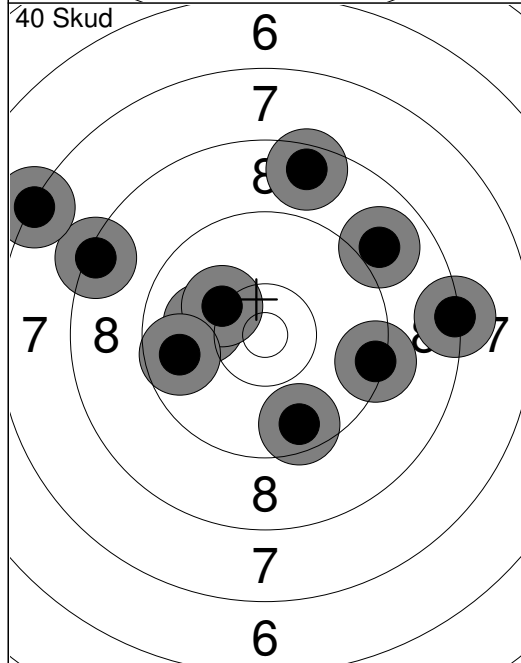

21: 10.1	←
22: 10.2	↖
23: 8.3	→
24: 9.7	←
25: 8.4	←
26: 7.3	↖
27: 8.6	↑
28: 8.9	↗
29: 9.6	↓
30: 9.4	→
Serie 86.0	
Total 266.0	

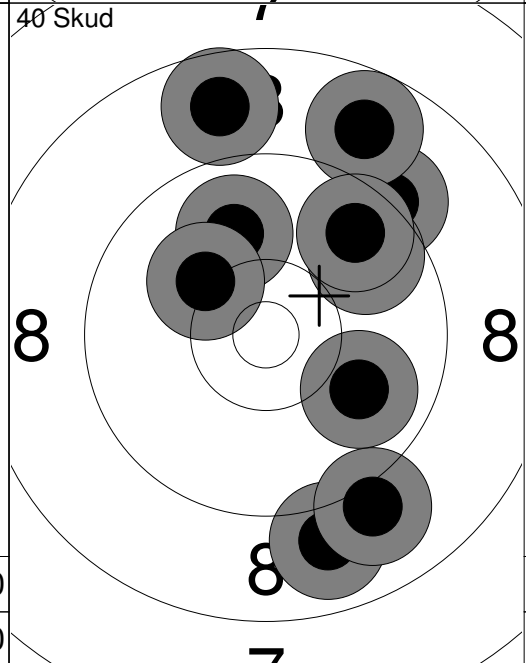

31: 8.9	↓
32: 9.2	↗
33: 8.8	↗
34: 9.0	↓
35: 9.9	↑
36: 9.7	↗
37: 9.7	↗
38: 10.2	↖
39: 8.7	↑
40: 9.9	→
Serie 88.0	
Total 354.0	

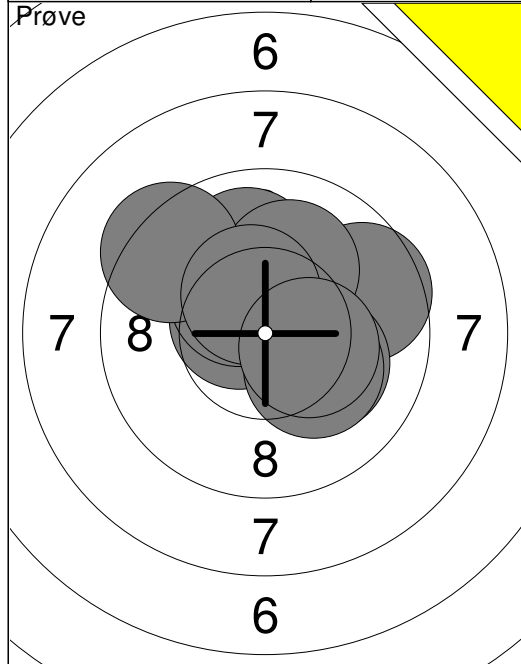

1:	*10.6 ↘
2:	*10.4 ↘
3:	9.6 →
4:	10.0 ↑
5:	*10.2 ↘
6:	10.1 ↑
7:	9.4 ↘
8:	*10.4 ↗
9:	*10.2 ↘
10:	*10.4 ↘
Serie 98.0	
Total 0.0	

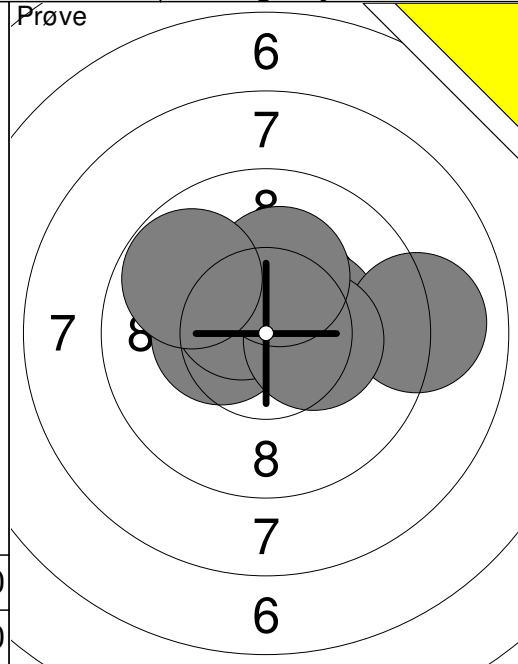

11:	*10.4 ↗
12:	*10.3 →
13:	*10.3 ↘
14:	*10.4 ←
15:	*10.5 ↘
16:	9.0 →
17:	*10.3 →
18:	*10.2 ↑
19:	9.8 ↖
Serie 88.0	
Total 0.0	

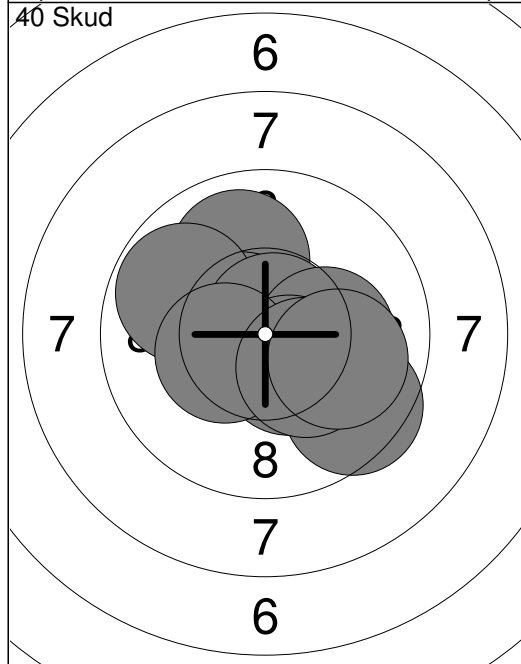

1:	10.0 ↑
2:	9.5 ↘
3:	*10.6 ↘
4:	9.8 ↖
5:	*10.8 ↗
6:	*10.2 →
7:	*10.4 ↘
8:	*10.4 ←
9:	*10.3 ↘
10:	10.0 →
Serie 98.0	
Total 98.0	

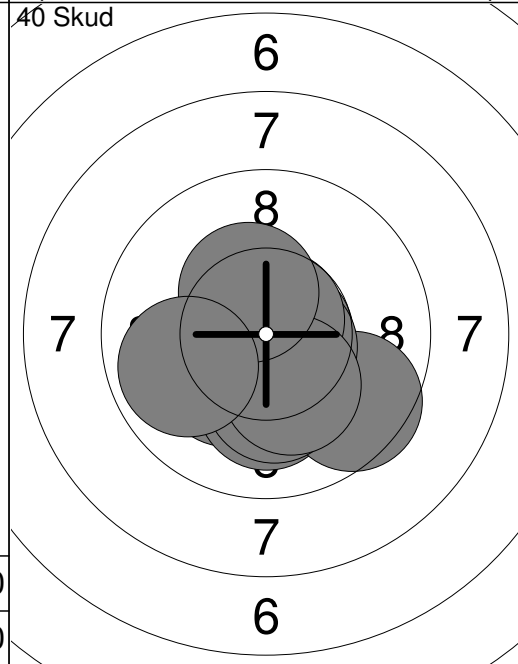

11:	*10.2 ↘
12:	*10.7 →
13:	10.1 ↓
14:	9.6 ↘
15:	*10.6 ↘
16:	*10.2 ↓
17:	*10.7 ↗
18:	*10.2 ↓
19:	*10.4 ↗
20:	9.9 ←
Serie 98.0	
Total 196.0	

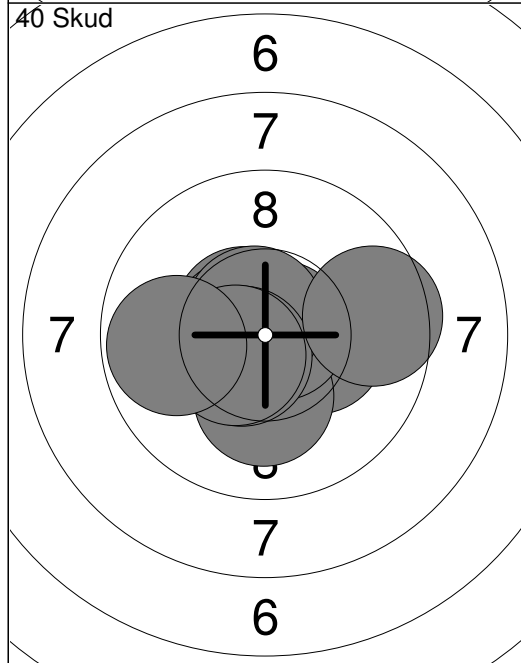

21:	*10.6 ↘
22:	*10.3 →
23:	*10.2 ↓
24:	*10.8 →
25:	*10.6 ↘
26:	*10.7 ↗
27:	*10.5 ↘
28:	*10.5 ↘
29:	9.6 →
30:	9.8 ←
Serie 98.0	
Total 294.0	

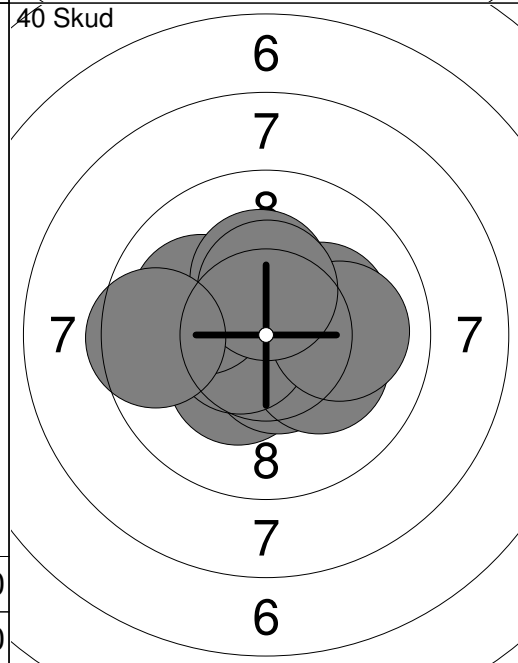

31:	*10.3 ↘
32:	*10.5 ↓
33:	*10.2 ↘
34:	*10.2 →
35:	*10.6 ↘
36:	10.0 ↖
37:	*10.2 ↑
38:	10.0 →
39:	*10.4 ↑
40:	9.5 ←
Serie 99.0	
Total 393.0	

<p>Prøve</p>	<p>1: 6.2 ↘ 2: 9.0 → 3: 8.7 ↘ 4: 8.2 ↘ 5: 9.9 ↘ 6: 9.4 ← 7: 9.9 → 8: 9.2 ↗ 9: 10.0 ↑ 10: *10.4 ↘</p> <p>Serie 87.0 Total 0.0</p>	<p>Prøve</p>	<p>11: *10.2 ← 12: *10.3 ↘ 13: 10.1 → 14: 9.4 ↘ 15: 9.7 → 16: 9.7 ↗ 17: 10.1 → 18: 9.4 ↘ 19: 10.1 →</p> <p>Serie 86.0 Total 0.0</p>
--------------	--	--------------	---

<p>60 Skud</p>	<p>1: *10.5 ↘ 2: 9.1 ↘ 3: *10.5 ↘ 4: 10.1 ↗ 5: 9.9 → 6: *10.5 ↘ 7: 9.0 ↗ 8: 8.8 ↘ 9: 9.7 → 10: 9.5 ↘</p> <p>Serie 93.0 Total 93.0</p>	<p>60 Skud</p>	<p>11: 10.1 ↘ 12: *10.5 → 13: 9.6 ↘ 14: 10.1 ← 15: *10.4 → 16: *10.5 ← 17: 9.9 → 18: 9.2 ↗ 19: 9.1 ↗ 20: 8.6 ←</p> <p>Serie 94.0 Total 187.0</p>
----------------	---	----------------	--

<p>60 Skud</p>	<p>21: 9.9 → 22: *10.3 ↘ 23: *10.7 ↗ 24: 9.6 ← 25: 9.7 ↗ 26: *10.4 ↘ 27: 10.0 ↗ 28: 10.0 ↗ 29: 9.3 ← 30: 9.3 ↗</p> <p>Serie 95.0 Total 282.0</p>	<p>60 Skud</p>	<p>31: 9.5 ← 32: 10.1 → 33: 9.7 → 34: 9.4 → 35: 9.7 ↘ 36: *10.5 ↗ 37: *10.3 ↘ 38: *10.4 ↑ 39: 9.9 ← 40: *10.4 ↗</p> <p>Serie 95.0 Total 377.0</p>
----------------	--	----------------	---

<p>60 Skud</p>	<p>41: *10.3 ← 42: *10.5 ↑ 43: 8.8 ↗ 44: 9.7 ↗ 45: *10.3 ← 46: 9.9 ↗ 47: 9.8 → 48: 8.7 ↗ 49: 9.7 ↗ 50: *10.4 ↗</p> <p>Serie 92.0 Total 469.0</p>	<p>60 Skud</p>	<p>51: *10.2 ↗ 52: 10.1 ← 53: *10.4 ↘ 54: *10.6 → 55: 9.9 ← 56: 9.1 ← 57: *10.5 ↘ 58: 9.8 ↘ 59: *10.3 ↗ 60: 9.5 →</p> <p>Serie 96.0 Total 565.0</p>
----------------	--	----------------	---

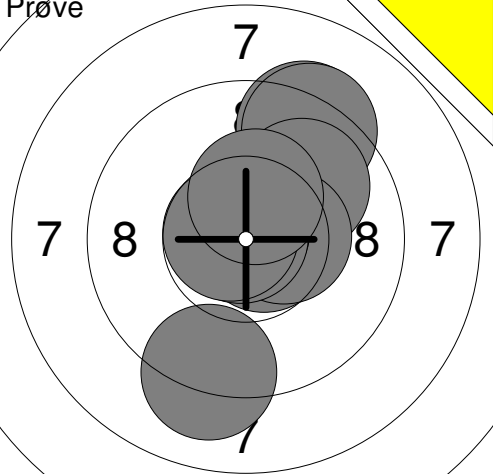
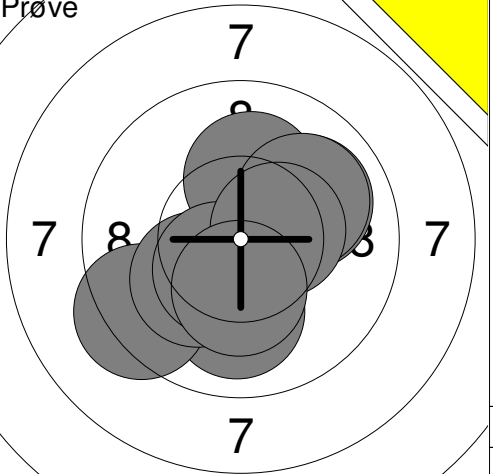
<p>Prøve</p> 	<p>1: 9.3 ↗ 2: 9.3 ↗ 3: *10.7 → 4: 9.9 ↗ 5: *10.4 → 6: *10.8 ↗ 7: *10.9 ↗ 8: *10.7 ↗ 9: *10.4 ↗ 10: 9.1 ↓</p>	<p>Prøve</p> 	<p>11: *10.3 ↗ 12: 10.0 ↓ 13: 9.3 ↙ 14: *10.2 ↙ 15: 10.1 ↗ 16: 10.0 ↗ 17: *10.5 ↙ 18: 10.0 ↗ 19: *10.4 → 20: *10.3 ↓</p>
Serie 96.0		Serie 99.0	
Total 0.0		Total 0.0	

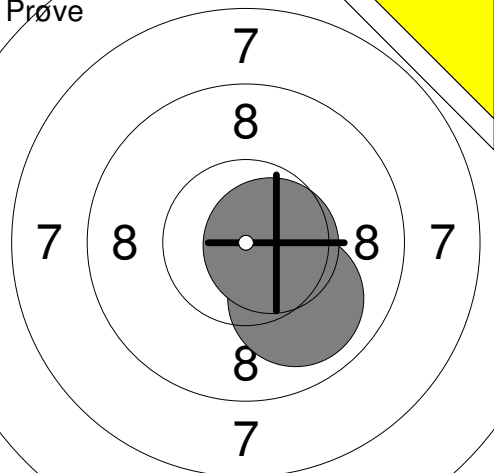
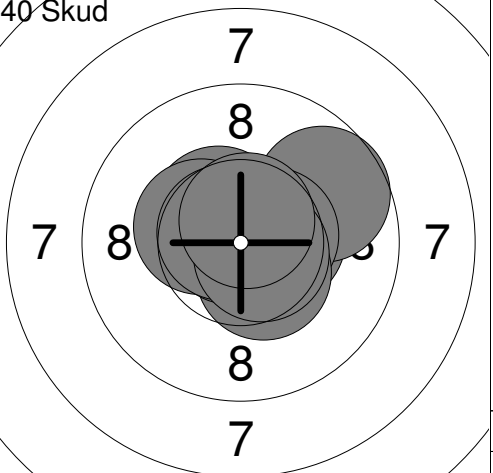
<p>Prøve</p> 	<p>21: 10.0 ↓ 22: *10.6 →</p>	<p>40 Skud</p> 	<p>1: *10.5 → 2: 9.7 ↗ 3: *10.5 → 4: *10.5 ↗ 5: *10.5 ↓ 6: *10.4 ↗ 7: *10.8 ↗ 8: *10.7 ↗ 9: *10.6 ↓ 10: *10.6 ↗</p>
Serie 20.0		Serie 99.0	
Total 0.0		Total 99.0	

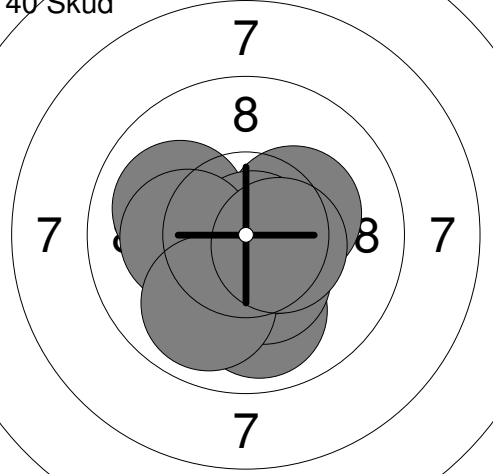
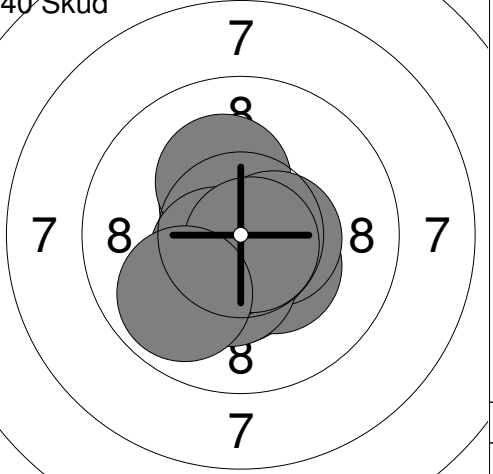
<p>40 Skud</p> 	<p>11: *10.6 → 12: 10.0 ↗ 13: 9.9 ↓ 14: *10.4 ↓ 15: *10.6 ↓ 16: *10.3 → 17: *10.8 ↓ 18: *10.2 ← 19: 9.9 ↓ 20: *10.5 →</p>	<p>40 Skud</p> 	<p>21: *10.4 ↓ 22: *10.4 ↓ 23: *10.5 ↗ 24: *10.2 ↗ 25: *10.5 → 26: *10.7 ↓ 27: *10.4 ↓ 28: *10.5 ↙ 29: *10.8 ↓ 30: 9.9 ↙</p>
Serie 98.0		Serie 99.0	
Total 197.0		Total 296.0	

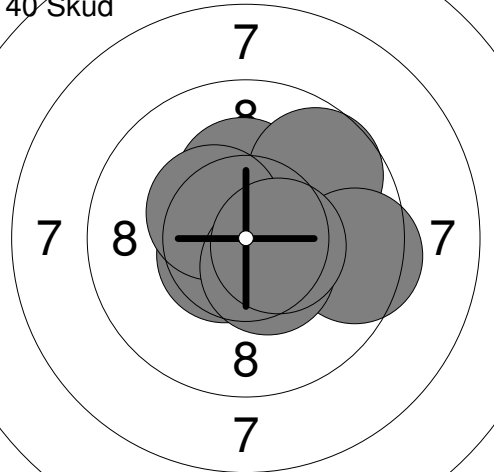
<p>40 Skud</p> 	<p>31: *10.5 ↓ 32: *10.8 ↓ 33: *10.6 → 34: *10.2 ↗ 35: 9.7 ↗ 36: 9.5 → 37: *10.6 ↙ 38: *10.4 ↗ 39: *10.5 ↓ 40: *10.5 →</p>		
Serie 98.0			
Total 394.0			

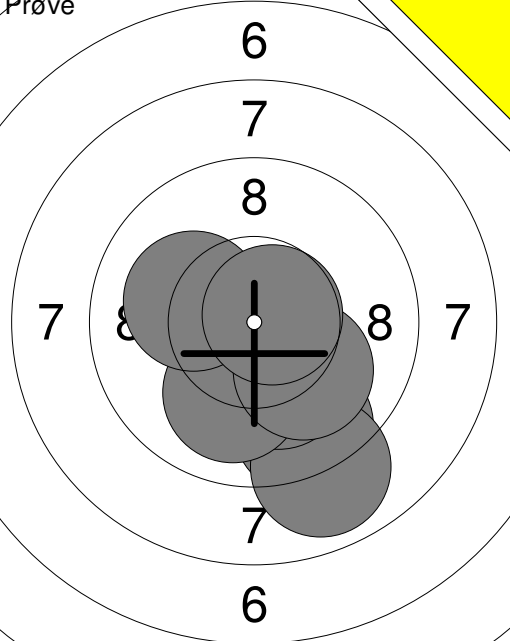
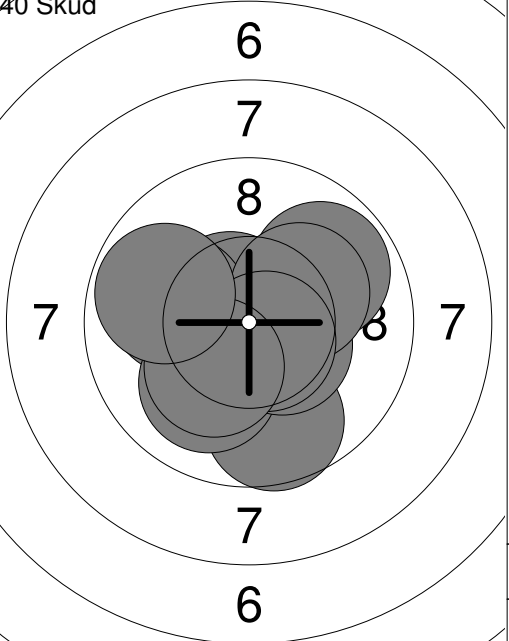
Prøve 	1: 9.5 ↓ 2: 8.9 ↓ 3: *10.5 ↘ 4: *10.2 ↓ 5: 10.0 ↓ 6: 10.1 ← 7: 10.1 ↓ 8: *10.7 →	40 Skud 	1: 9.7 ↓ 2: *10.6 ↘ 3: 10.0 ← 4: 10.0 ↓ 5: 9.8 ↗ 6: *10.4 ↘ 7: *10.2 ↗ 8: *10.6 ↓ 9: *10.2 ↓ 10: 9.8 ←
	Serie 77.0		Serie 97.0
	Total 0.0		Total 97.0

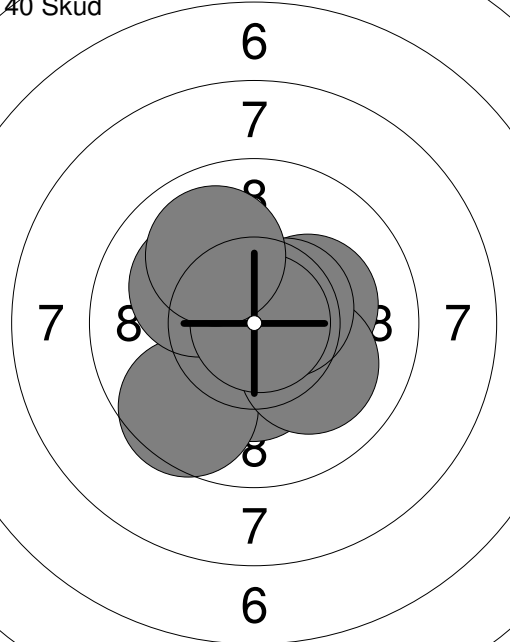
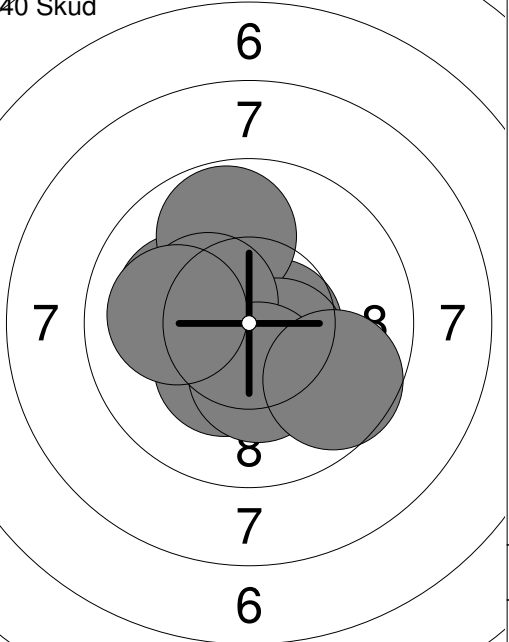
40 Skud 	11: *10.6 ↗ 12: *10.7 → 13: *10.3 ↓ 14: 9.6 ↓ 15: *10.2 → 16: 10.1 ← 17: 10.1 ↓ 18: *10.5 → 19: *10.9 → 20: 10.0 ↖	40 Skud 	21: *10.6 → 22: 10.1 ← 23: 9.8 ↑ 24: *10.6 ↓ 25: *10.3 ↓ 26: *10.5 ↘ 27: *10.4 ← 28: *10.3 ↓ 29: 10.0 ← 30: 9.7 ↓
	Serie 99.0		Serie 98.0
	Total 196.0		Total 294.0

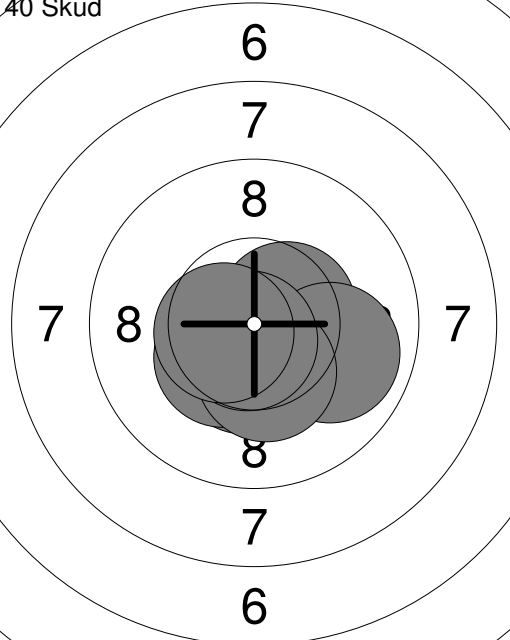
40 Skud 	31: *10.5 ↓ 32: *10.7 → 33: *10.6 → 34: *10.4 ↓ 35: *10.5 → 36: 9.9 → 37: *10.4 ↓ 38: *10.3 ↓ 39: *10.7 ↓ 40: *10.5 ←	
	Serie 99.0	
	Total 393.0	

Prøve 	1: *10.9 ↙ 2: *10.9 ↘ 3: *10.2 ↑ 4: *10.4 ↑ 5: *10.5 ↘ 6: 9.8 ← 7: 9.7 ↑ 8: *10.6 ↑ 9: *10.2 → 10: 9.9 → Serie 97.0 Total 0.0	Prøve 	11: *10.6 ↑ 12: 9.9 ↙ 13: 10.1 → 14: *10.4 ↑ 15: *10.4 ↘ Serie 49.0 Total 0.0
---	--	---	---

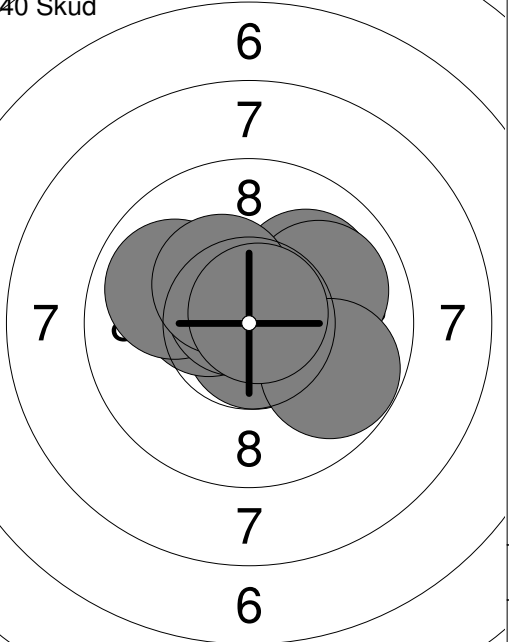
40 Skud 	1: *10.3 → 2: *10.4 ↘ 3: 10.0 ↓ 4: *10.8 ↓ 5: *10.5 ↓ 6: 9.0 → 7: 10.1 ↓ 8: 9.8 ↓ 9: 9.4 ← 10: *10.3 → Serie 97.0 Total 97.0	40 Skud 	11: 10.0 ↗ 12: *10.7 ↓ 13: 10.0 → 14: *10.4 ↙ 15: *10.4 ↙ 16: 9.9 ← 17: *10.7 ↗ 18: 9.8 → 19: *10.3 ↗ 20: *10.8 ↗ Serie 98.0 Total 195.0
--	---	--	---

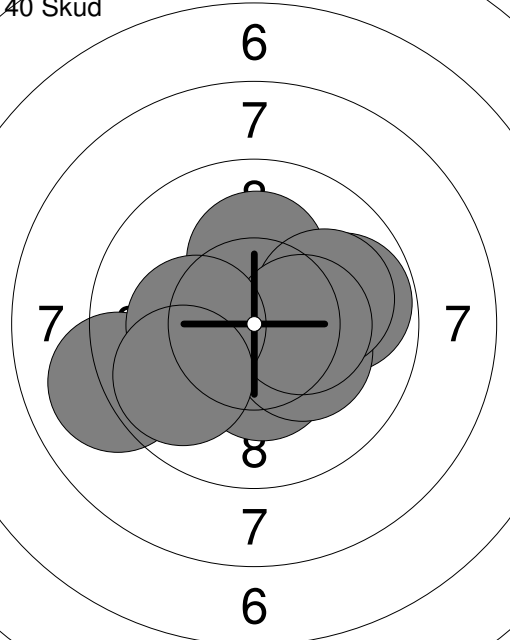
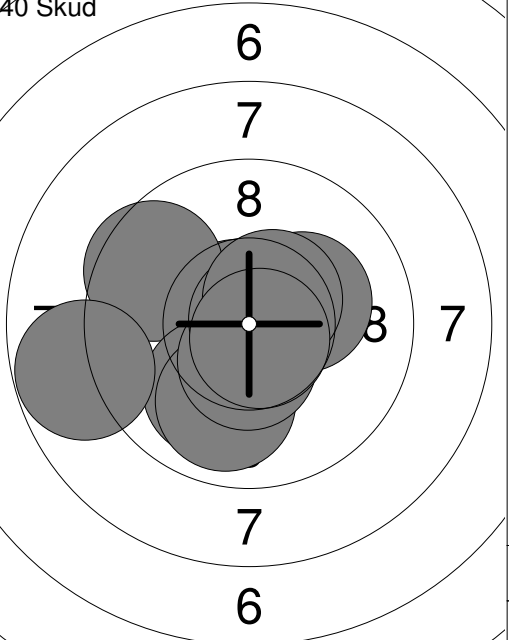
40 Skud 	21: *10.3 ↓ 22: 9.1 ← 23: *10.7 ↑ 24: 9.8 → 25: 10.1 ↑ 26: *10.2 ↘ 27: 10.0 → 28: *10.3 → 29: *10.2 ↙ 30: 9.8 ← Serie 97.0 Total 292.0	40 Skud 	31: *10.2 → 32: *10.7 ↗ 33: 9.6 ← 34: 10.0 ↓ 35: 8.8 ← 36: 9.9 ↓ 37: *10.5 ↓ 38: *10.8 → 39: *10.5 ↗ 40: *10.7 ↓ Serie 96.0 Total 388.0
---	---	---	--

<p>Prøve</p> 	<p>1: 9.8 →</p> <p>2: *10.2 ↘</p> <p>3: *10.3 ↘</p> <p>4: *10.2 ↗</p> <p>5: *10.9 ↘</p> <p>6: 10.0 ↙</p> <p>7: *10.6 ↘</p> <p>8: 9.9 ↗</p> <p>9: 9.8 ←</p> <p>10: *10.7 ↗</p>	<p>Prøve</p> 	<p>11: *10.3 ↗</p> <p>12: *10.2 ↘</p> <p>13: *10.5 ↘</p> <p>14: *10.6 ↗</p> <p>15: 9.9 ←</p> <p>16: *10.6 ↗</p>
Serie 97.0	Total 0.0	Serie 59.0	Total 0.0

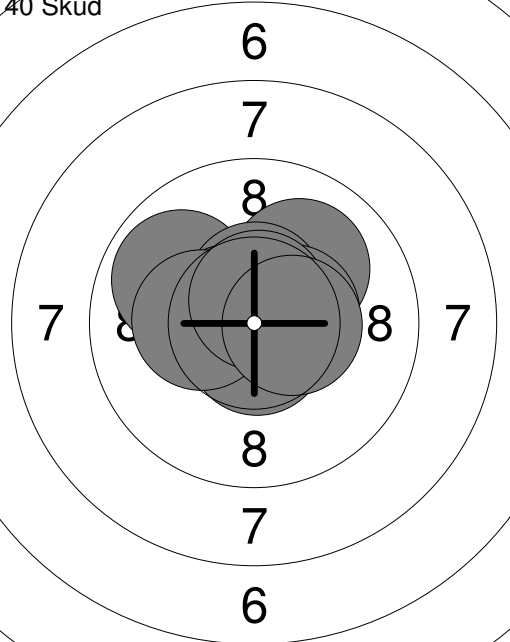
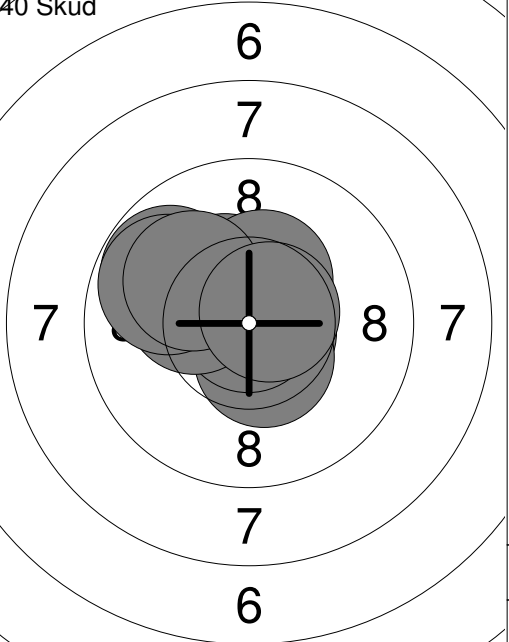
<p>40 Skud</p> 	<p>1: 10.0 ↗</p> <p>2: *10.6 ↗</p> <p>3: 9.9 ←</p> <p>4: *10.6 ↗</p> <p>5: *10.6 ↗</p> <p>6: *10.7 ↘</p> <p>7: *10.3 ↗</p> <p>8: *10.5 →</p> <p>9: *10.7 ↗</p> <p>10: *10.5 →</p>	<p>40 Skud</p> 	<p>11: *10.7 ↘</p> <p>12: *10.4 ↗</p> <p>13: 9.8 ←</p> <p>14: *10.5 ↘</p> <p>15: *10.9 ↗</p> <p>16: *10.2 ↗</p> <p>17: 9.8 ←</p> <p>18: *10.4 ↗</p> <p>19: 10.1 ↗</p> <p>20: *10.7 ↗</p>
Serie 99.0	Total 99.0	Serie 98.0	Total 197.0

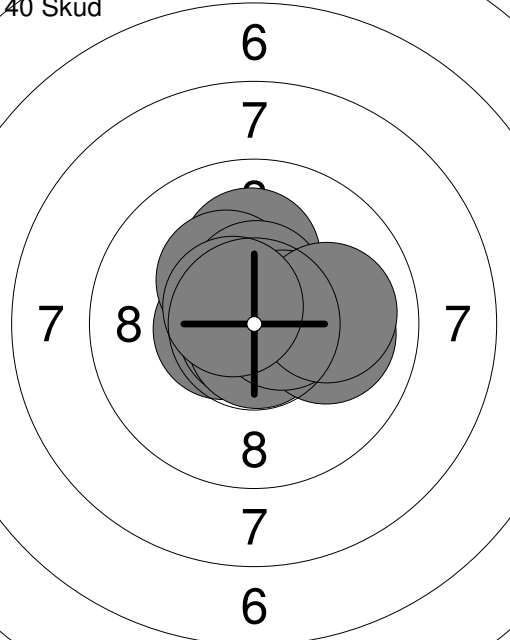
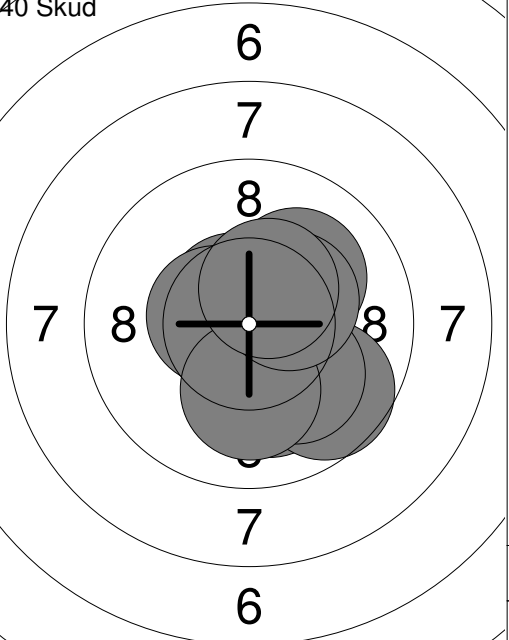
<p>40 Skud</p> 	<p>21: *10.5 ↗</p> <p>22: 10.1 ↗</p> <p>23: *10.8 ↘</p> <p>24: *10.3 ↗</p> <p>25: *10.5 ↗</p> <p>26: *10.8 ↘</p> <p>27: 10.0 →</p> <p>28: *10.6 →</p> <p>29: 10.0 →</p> <p>30: *10.6 ↗</p>	<p>40 Skud</p> 	<p>31: 10.1 ↘</p> <p>32: 9.7 ↘</p> <p>33: 10.1 ↘</p> <p>34: 10.1 ↗</p> <p>35: *10.6 ↗</p> <p>36: *10.8 ↗</p> <p>37: *10.5 ↗</p> <p>38: 10.1 ↘</p> <p>39: *10.4 ↗</p> <p>40: *10.4 ↗</p>
Serie 100.0	Total 297.0	Serie 99.0	Total 396.0

Prøve 	1: 10.0 ↗ 2: 9.5 ↗ 3: 10.1 ← 4: *10.6 → 5: *10.4 ↗ 6: 10.0 ↗ 7: 9.4 → 8: *10.3 ↓ 9: *10.5 ↘ 10: 9.6 ↗ Serie 97.0 Total 0.0	Prøve 	11: 9.9 ↖ 12: 10.1 ↙ 13: *10.3 ↘ 14: 9.3 ↘ 15: *10.3 ↘ 16: *10.4 → 17: 9.0 ← 18: 9.4 ↙ 19: *10.3 ↘ Serie 86.0 Total 0.0
---	---	---	---

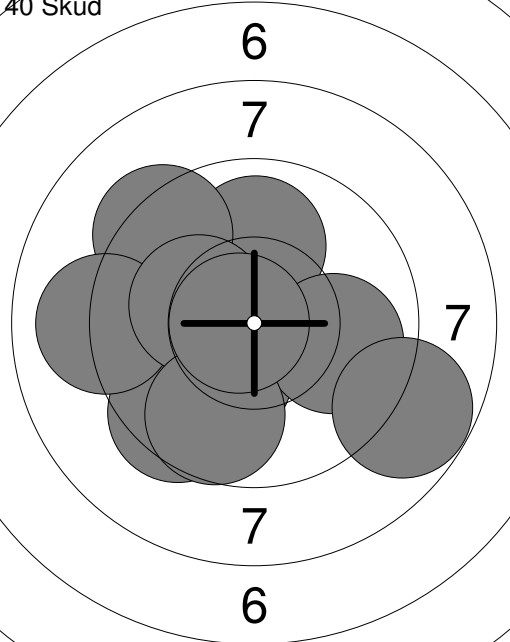
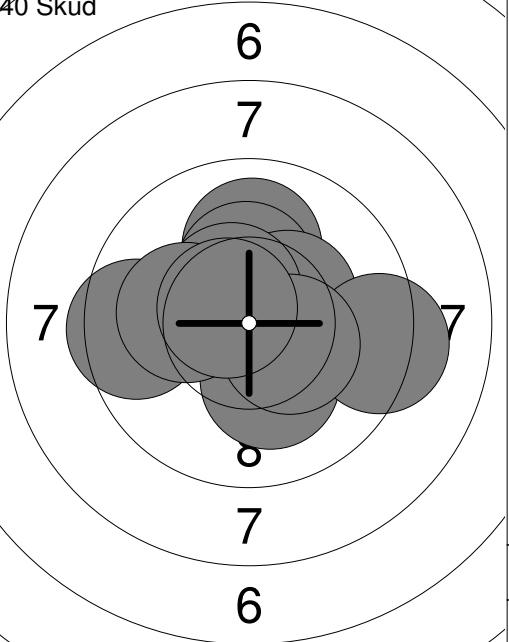
40 Skud 	1: *10.2 ↘ 2: 9.5 ↘ 3: 10.0 ↑ 4: 9.3 ↖ 5: 9.1 ← 6: *10.2 ↘ 7: 9.9 → 8: 9.7 ↓ 9: *10.8 ← 10: 8.8 → Serie 93.0 Total 93.0	40 Skud 	11: 10.0 ↑ 12: *10.3 ↑ 13: *10.4 → 14: *10.5 ↖ 15: *10.2 ↓ 16: 9.3 → 17: 9.5 ← 18: 10.1 ← 19: *10.4 → 20: *10.6 ↖ Serie 98.0 Total 191.0
--	--	--	---

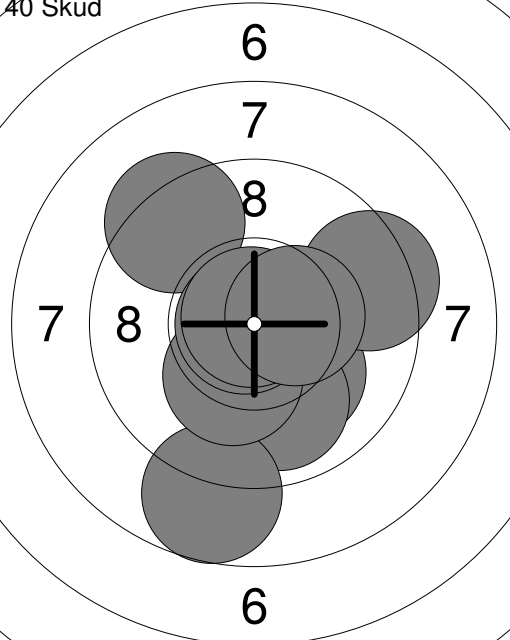
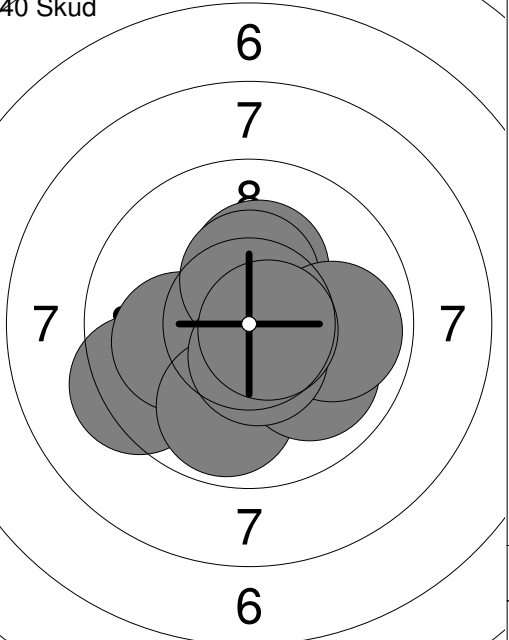
40 Skud 	21: *10.9 → 22: 9.3 ↗ 23: 10.1 ↘ 24: 9.9 ↓ 25: 8.7 ↓ 26: 9.4 → 27: *10.2 ↘ 28: *10.8 ← 29: *10.9 ↖ 30: *10.4 → Serie 95.0 Total 286.0	40 Skud 	31: 9.4 ↖ 32: *10.8 ↘ 33: 10.1 ← 34: 9.9 ↓ 35: 10.0 ↘ 36: *10.3 ↑ 37: *10.4 ↑ 38: 9.9 → 39: *10.5 ↓ 40: *10.7 → Serie 97.0 Total 383.0
---	--	---	---

Prøve	6 7 8 8 7 6	1: *10.6 ↑ 2: 9.5 ↗ 3: 8.9 → 4: 7.8 ← 5: 9.9 ↑ 6: 9.6 ↗ 7: 9.5 → 8: 10.1 → 9: 9.3 ↗ 10: 8.7 →	Prøve	5 6 7 8 8 7 6	11: 9.0 ↘ 12: *10.4 ↓ 13: 9.3 ← 14: 8.2 → 15: *10.8 ↓ 16: 9.1 ← 17: *10.4 ↓ 18: 9.2 ↖ 19: 8.6 ↗ 20: 7.1 →
		Serie 88.0			Serie 89.0
		Total 0.0			Total 0.0

Prøve	7 7 8 7	21: 9.4 → 22: 9.4 ← 23: *10.6 → 24: *10.4 ↑ 25: 9.9 ↓ 26: *10.4 ↑ 27: 9.6 ↑ 28: 9.4 ↘ 29: 9.7 ↘ 30: 9.7 ↑	60 Skud	5 6 7 8 8 7 6	1: *10.4 → 2: *10.4 ↓ 3: *10.7 ↓ 4: 9.8 → 5: *10.4 ↓ 6: 8.1 → 7: 8.7 ↓ 8: 8.0 ↘ 9: 7.3 ↖ 10: *10.3 ↖
		Serie 93.0			Serie 90.0
		Total 0.0			Total 90.0

60 Skud	7 8 8 7	11: 9.0 → 12: *10.5 ↓ 13: 8.7 → 14: 8.7 ↘ 15: 9.9 ← 16: 10.1 → 17: *10.3 ↘ 18: *10.5 ↑ 19: 9.6 → 20: *10.3 ↗	60 Skud	5 7 8 8 7	21: 9.3 ↗ 22: 9.9 ↓ 23: *10.4 ↓ 24: *10.6 ↓ 25: *10.4 ↖ 26: 8.2 ↘ 27: 9.4 ↓ 28: 8.3 ↘ 29: 9.3 ↘ 30: *10.2 →
		Serie 93.0			Serie 92.0
		Total 183.0			Total 275.0

60 Skud	6 7 8 8 7 6	31: 9.8 ↘ 32: 9.8 ↗ 33: *10.5 ↖ 34: 9.2 ↖ 35: 8.7 ↘ 36: 7.9 ↘ 37: 8.3 ↖ 38: 8.7 ← 39: *10.9 ↑ 40: 9.9 ←	60 Skud	6 7 8 8 7 6	41: *10.2 ↘ 42: 9.5 ← 43: 9.3 ↓ 44: 9.5 ↘ 45: *10.2 ↑ 46: *10.3 → 47: 9.3 ↓ 48: *10.7 ↗ 49: 9.8 ↗ 50: 8.3 ↘
		Serie 87.0			Serie 93.0
		Total 362.0			Total 455.0

60 Skud	7 8 8 7	51: 9.7 → 52: 8.7 → 53: *10.5 ↗ 54: 9.5 → 55: 9.8 ↓ 56: *10.2 → 57: 8.7 ← 58: 10.1 ↑ 59: 8.4 → 60: *10.2 ←			
		Serie 91.0			
		Total 546.0			

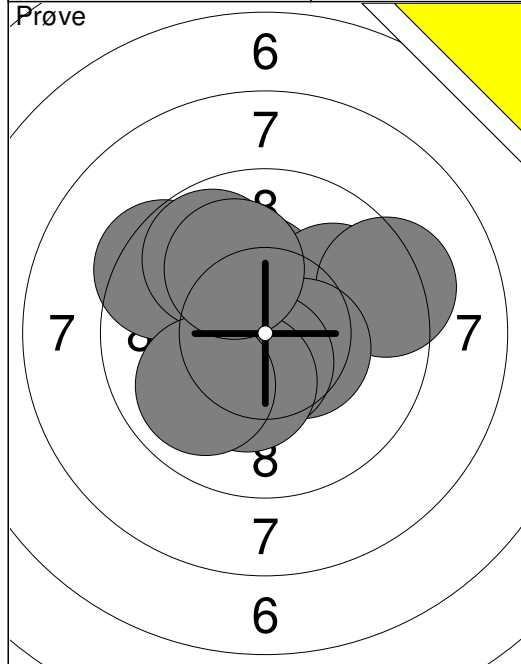

1:	*10.3 ↗
2:	9.9 →
3:	9.3 →
4:	*10.5 ↘
5:	9.4 ↖
6:	*10.6 ↓
7:	9.8 ↖
8:	*10.3 ↓
9:	9.9 ↙
10:	10.0 ↖
Serie 95.0	
Total 0.0	

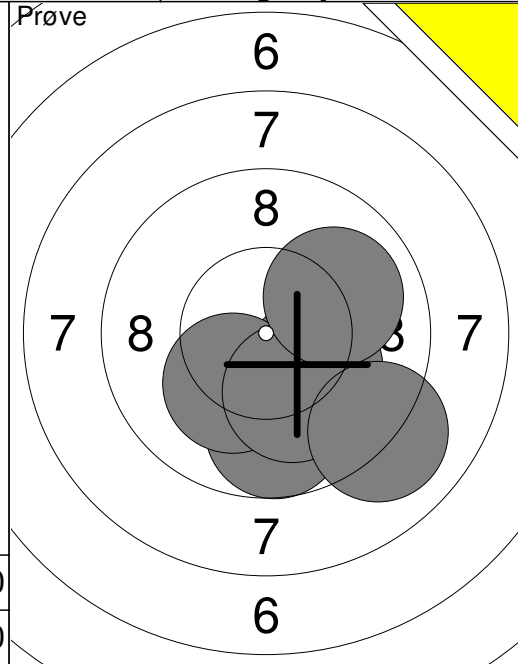

11:	9.7 ↓
12:	*10.2 ↘
13:	*10.2 ↙
14:	10.1 ↓
15:	10.0 →
16:	9.0 ↘
Serie 58.0	
Total 0.0	

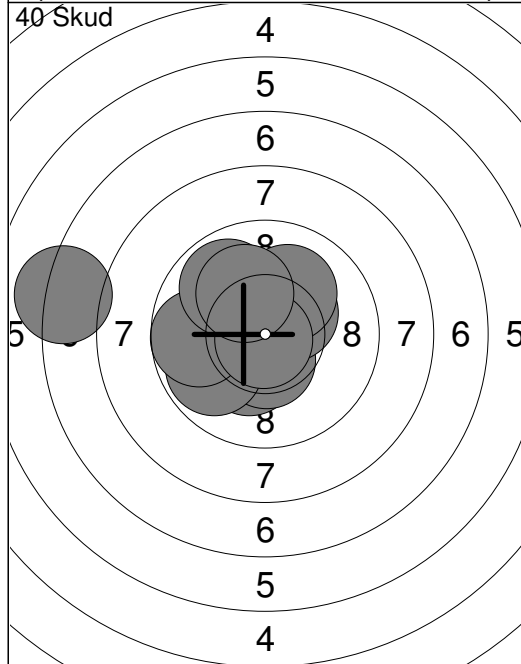

1:	*10.3 ↓
2:	*10.5 ↓
3:	9.8 ↖
4:	9.7 ←
5:	*10.4 ↗
6:	10.1 ↗
7:	7.2 ←
8:	*10.8 ↓
9:	9.9 ↖
10:	10.1 ↖
Serie 94.0	
Total 94.0	

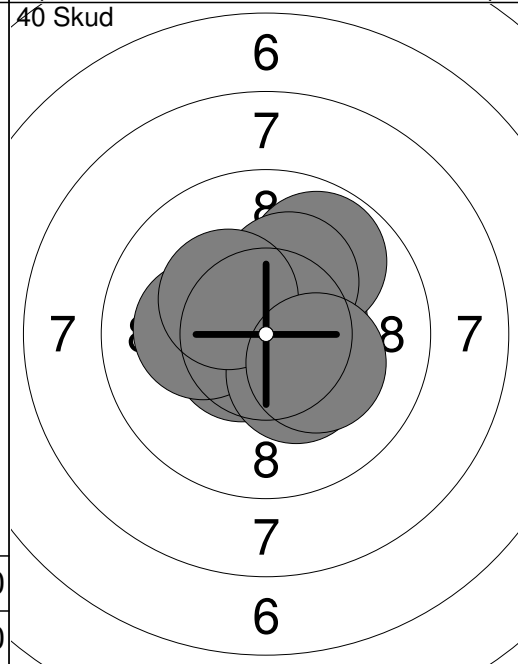

11:	*10.5 ↗
12:	9.8 ↗
13:	*10.7 ↖
14:	*10.6 ↖
15:	*10.6 ↙
16:	*10.2 ↖
17:	*10.2 ↗
18:	*10.3 ↓
19:	*10.3 ↖
20:	*10.2 ↘
Serie 99.0	
Total 193.0	

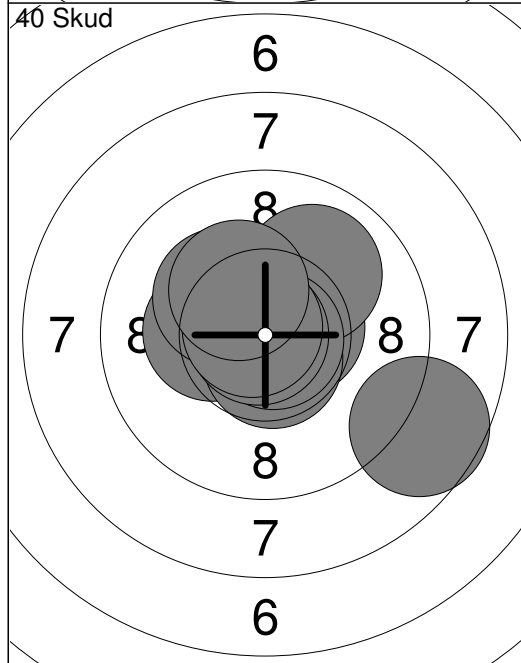

21:	*10.3 ↖
22:	*10.6 →
23:	10.0 ↗
24:	*10.6 ↓
25:	*10.8 ↘
26:	*10.2 ↖
27:	*10.9 ↖
28:	*10.8 ↖
29:	8.7 →
30:	*10.3 ↖
Serie 98.0	
Total 291.0	

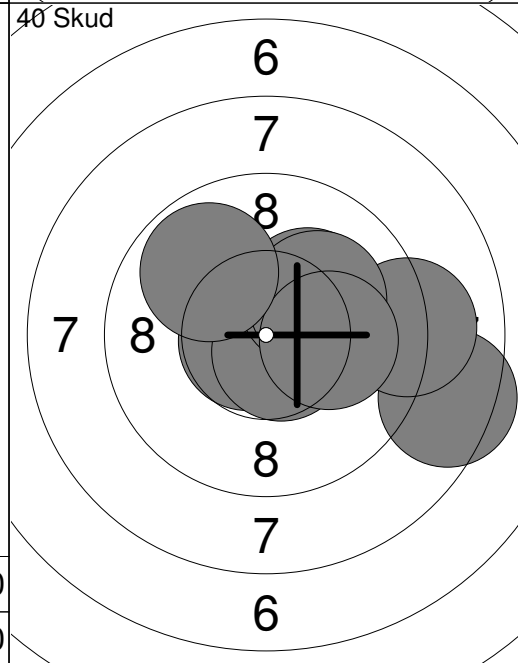

31:	*10.6 →
32:	8.5 →
33:	*10.7 ↖
34:	10.0 →
35:	*10.7 ↘
36:	*10.2 ↗
37:	9.1 →
38:	10.1 ↗
39:	10.1 →
40:	9.8 ↖
Serie 96.0	
Total 387.0	

Prøve 	Prøve 	<table style="width:100%; border-collapse: collapse;"> <tr><td>1: 8.5 ↘</td><td>11: 9.4 →</td></tr> <tr><td>2: 9.4 →</td><td>12: *10.3 ↗</td></tr> <tr><td>3: *10.3 ↘</td><td>13: *10.3 ↘</td></tr> <tr><td>4: 9.2 ↙</td><td>14: *10.4 ↗</td></tr> <tr><td>5: 9.5 ↘</td><td>15: *10.7 ↑</td></tr> <tr><td>6: 9.5 ↘</td><td>16: 8.9 →</td></tr> <tr><td>7: 10.1 ↙</td><td>17: 9.6 →</td></tr> <tr><td>8: 9.1 →</td><td>18: *10.7 →</td></tr> <tr><td>9: 8.2 →</td><td></td></tr> <tr><td>10: *10.4 ↑</td><td></td></tr> <tr><td colspan="2" style="border-top: 1px solid black;">Serie 91.0</td></tr> <tr><td colspan="2" style="border-top: 1px solid black;">Total 0.0</td></tr> </table>	1: 8.5 ↘	11: 9.4 →	2: 9.4 →	12: *10.3 ↗	3: *10.3 ↘	13: *10.3 ↘	4: 9.2 ↙	14: *10.4 ↗	5: 9.5 ↘	15: *10.7 ↑	6: 9.5 ↘	16: 8.9 →	7: 10.1 ↙	17: 9.6 →	8: 9.1 →	18: *10.7 →	9: 8.2 →		10: *10.4 ↑		Serie 91.0		Total 0.0	
1: 8.5 ↘	11: 9.4 →																									
2: 9.4 →	12: *10.3 ↗																									
3: *10.3 ↘	13: *10.3 ↘																									
4: 9.2 ↙	14: *10.4 ↗																									
5: 9.5 ↘	15: *10.7 ↑																									
6: 9.5 ↘	16: 8.9 →																									
7: 10.1 ↙	17: 9.6 →																									
8: 9.1 →	18: *10.7 →																									
9: 8.2 →																										
10: *10.4 ↑																										
Serie 91.0																										
Total 0.0																										

40 Skud 	40 Skud 	<table style="width:100%; border-collapse: collapse;"> <tr><td>1: 10.0 ↗</td><td>11: *10.2 →</td></tr> <tr><td>2: 9.4 ↘</td><td>12: 9.5 ←</td></tr> <tr><td>3: *10.6 ↘</td><td>13: 9.7 →</td></tr> <tr><td>4: *10.8 ↗</td><td>14: 9.9 ↗</td></tr> <tr><td>5: *10.5 ↘</td><td>15: *10.7 →</td></tr> <tr><td>6: *10.3 →</td><td>16: *10.2 ↘</td></tr> <tr><td>7: 8.7 ↘</td><td>17: 9.1 ←</td></tr> <tr><td>8: 9.5 ↘</td><td>18: *10.2 ↑</td></tr> <tr><td>9: 9.7 ↘</td><td>19: *10.5 ↗</td></tr> <tr><td>10: 9.0 ↗</td><td>20: *10.5 ↘</td></tr> <tr><td colspan="2" style="border-top: 1px solid black;">Serie 94.0</td></tr> <tr><td colspan="2" style="border-top: 1px solid black;">Total 94.0</td></tr> </table>	1: 10.0 ↗	11: *10.2 →	2: 9.4 ↘	12: 9.5 ←	3: *10.6 ↘	13: 9.7 →	4: *10.8 ↗	14: 9.9 ↗	5: *10.5 ↘	15: *10.7 →	6: *10.3 →	16: *10.2 ↘	7: 8.7 ↘	17: 9.1 ←	8: 9.5 ↘	18: *10.2 ↑	9: 9.7 ↘	19: *10.5 ↗	10: 9.0 ↗	20: *10.5 ↘	Serie 94.0		Total 94.0	
1: 10.0 ↗	11: *10.2 →																									
2: 9.4 ↘	12: 9.5 ←																									
3: *10.6 ↘	13: 9.7 →																									
4: *10.8 ↗	14: 9.9 ↗																									
5: *10.5 ↘	15: *10.7 →																									
6: *10.3 →	16: *10.2 ↘																									
7: 8.7 ↘	17: 9.1 ←																									
8: 9.5 ↘	18: *10.2 ↑																									
9: 9.7 ↘	19: *10.5 ↗																									
10: 9.0 ↗	20: *10.5 ↘																									
Serie 94.0																										
Total 94.0																										

40 Skud 	40 Skud 	<table style="width:100%; border-collapse: collapse;"> <tr><td>21: *10.6 →</td><td>31: 8.2 ←</td></tr> <tr><td>22: 9.7 ↘</td><td>32: 9.1 ←</td></tr> <tr><td>23: *10.3 ↘</td><td>33: *10.4 ↘</td></tr> <tr><td>24: 9.8 →</td><td>34: 9.8 ←</td></tr> <tr><td>25: 9.1 →</td><td>35: 9.9 ↘</td></tr> <tr><td>26: *10.5 ↘</td><td>36: 9.0 →</td></tr> <tr><td>27: 9.5 ↘</td><td>37: *10.3 →</td></tr> <tr><td>28: 9.8 →</td><td>38: 8.3 →</td></tr> <tr><td>29: 9.5 ↘</td><td>39: *10.7 ↗</td></tr> <tr><td>30: 9.7 ←</td><td>40: *10.5 ↑</td></tr> <tr><td colspan="2" style="border-top: 1px solid black;">Serie 93.0</td></tr> <tr><td colspan="2" style="border-top: 1px solid black;">Total 283.0</td></tr> </table>	21: *10.6 →	31: 8.2 ←	22: 9.7 ↘	32: 9.1 ←	23: *10.3 ↘	33: *10.4 ↘	24: 9.8 →	34: 9.8 ←	25: 9.1 →	35: 9.9 ↘	26: *10.5 ↘	36: 9.0 →	27: 9.5 ↘	37: *10.3 →	28: 9.8 →	38: 8.3 →	29: 9.5 ↘	39: *10.7 ↗	30: 9.7 ←	40: *10.5 ↑	Serie 93.0		Total 283.0	
21: *10.6 →	31: 8.2 ←																									
22: 9.7 ↘	32: 9.1 ←																									
23: *10.3 ↘	33: *10.4 ↘																									
24: 9.8 →	34: 9.8 ←																									
25: 9.1 →	35: 9.9 ↘																									
26: *10.5 ↘	36: 9.0 →																									
27: 9.5 ↘	37: *10.3 →																									
28: 9.8 →	38: 8.3 →																									
29: 9.5 ↘	39: *10.7 ↗																									
30: 9.7 ←	40: *10.5 ↑																									
Serie 93.0																										
Total 283.0																										

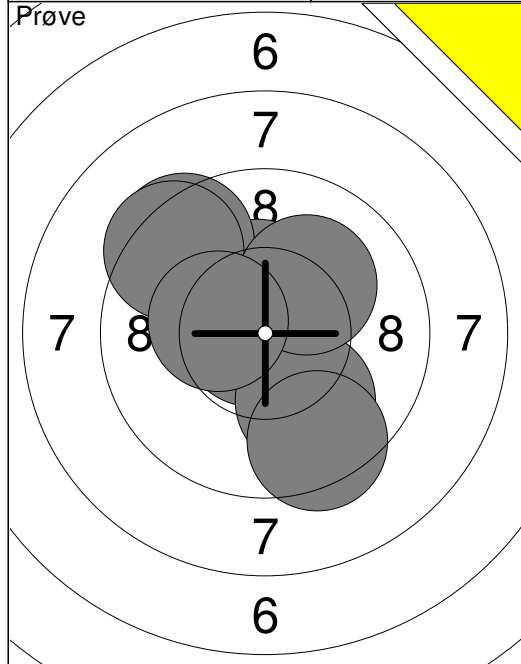

1:	*10.8 ↘
2:	*10.4 ↑
3:	*10.6 ↑
4:	9.4 ↗
5:	9.4 ↗
6:	*10.8 ↘
7:	9.9 ↓
8:	10.1 ↗
9:	*10.3 ↘
10:	9.4 ↓
Serie 96.0	
Total 0.0	

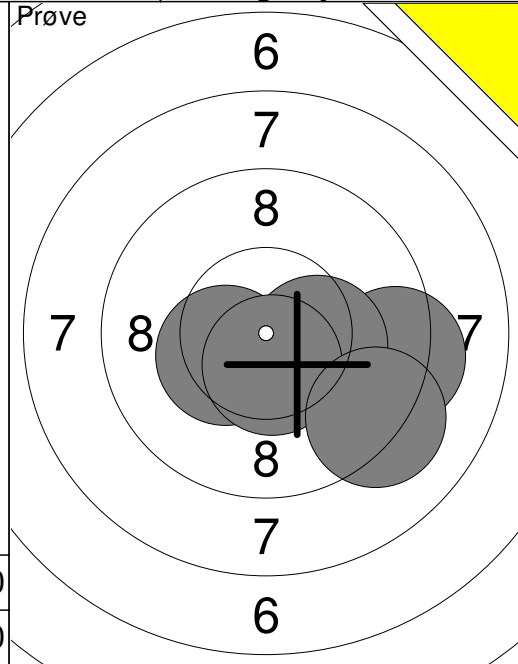

11:	*10.4 ↘
12:	9.3 →
13:	*10.3 →
14:	*10.5 ↓
15:	9.2 ↓
Serie 48.0	
Total 0.0	

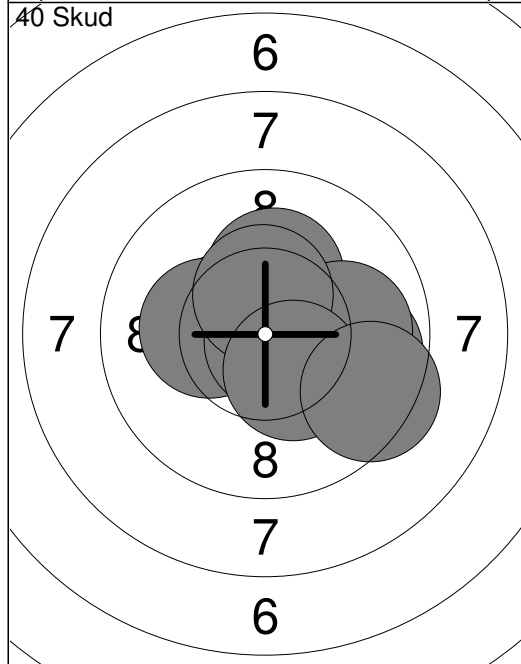

1:	*10.4 ↘
2:	9.8 →
3:	*10.2 ↘
4:	*10.2 ↑
5:	*10.8 ↘
6:	10.0 →
7:	10.0 →
8:	*10.5 ↑
9:	*10.4 ↘
10:	9.4 →
Serie 98.0	
Total 98.0	

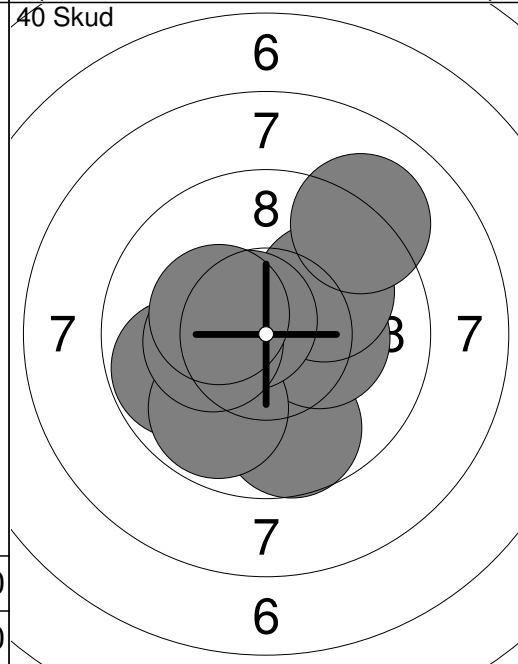

11:	*10.4 ↘
12:	9.7 ↓
13:	*10.3 →
14:	9.8 ←
15:	10.0 ↗
16:	9.8 ↓
17:	*10.7 ↘
18:	*10.3 ↘
19:	*10.3 ↘
20:	9.1 ↗
Serie 96.0	
Total 194.0	

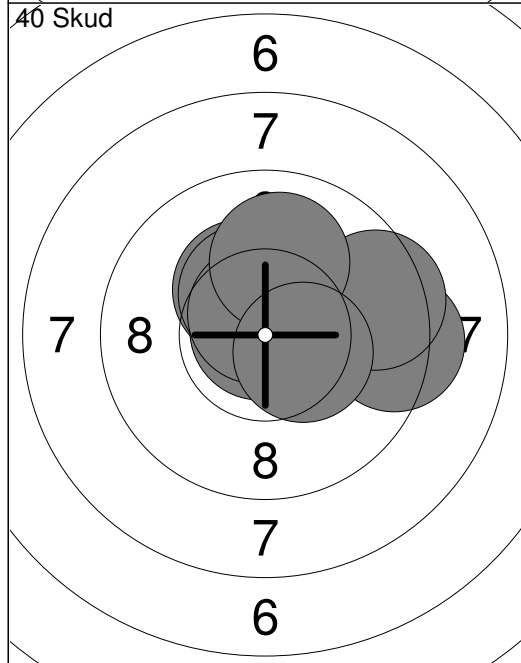

21:	*10.3 ↘
22:	*10.9 ↘
23:	*10.4 →
24:	9.3 →
25:	*10.6 ↑
26:	*10.4 ↘
27:	*10.7 ↗
28:	9.5 →
29:	10.0 ↑
30:	*10.4 →
Serie 98.0	
Total 292.0	

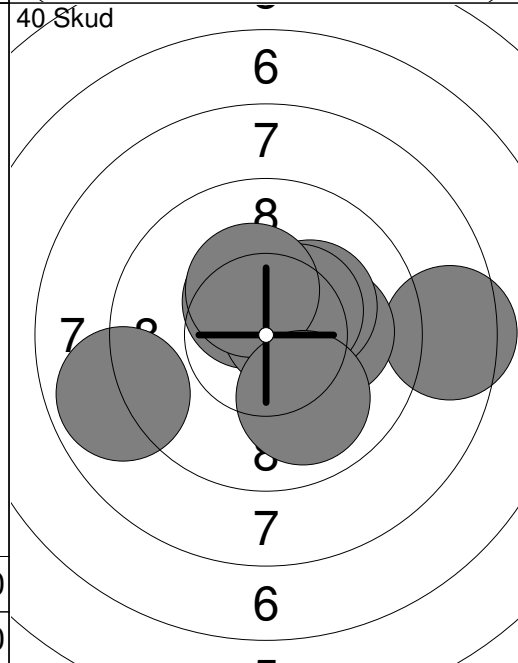

31:	*10.4 ↘
32:	*10.5 →
33:	8.5 →
34:	10.1 →
35:	*10.2 ↗
36:	*10.6 ↗
37:	*10.4 ↗
38:	8.9 ←
39:	*10.3 ↗
40:	10.0 ↓
Serie 96.0	
Total 388.0	

Prøve 	1: 9.2 ↗ 2: *10.5 → 3: *10.6 ↓ 4: 9.8 ↖ 5: 9.7 → 6: 9.4 → 7: 9.5 ↓ 8: 9.4 ↓ 9: *10.3 ← 10: *10.5 ↑ <hr/> Serie 94.0 Total 0.0	Prøve 	11: *10.3 → 12: 9.2 ← 13: *10.2 ↗ 14: *10.2 → 15: *10.4 ↓ 16: 9.8 ↗ 17: 9.8 ↓ 18: 8.8 ↓ 19: 10.0 ↓ 20: 9.7 ↓ <hr/> Serie 94.0 Total 0.0
-----------	--	-----------	--

Prøve 	21: *10.6 ↓ 22: 9.8 ↘ <hr/> Serie 19.0 Total 0.0	40 Skud 	1: 10.1 ↓ 2: 10.0 ↗ 3: *10.4 ↓ 4: 10.0 ← 5: *10.4 ← 6: *10.5 ↓ 7: *10.5 ↗ 8: *10.6 → 9: *10.3 ↗ 10: 10.1 ↗ <hr/> Serie 100.0 Total 100.0
-----------	---	-------------	---

40 Skud 	11: 10.1 ↑ 12: 10.1 ↖ 13: *10.3 ↗ 14: 9.1 ↗ 15: 9.6 ↗ 16: 9.9 ↑ 17: 9.5 ↗ 18: *10.7 ↑ 19: *10.2 ← 20: *10.2 → <hr/> Serie 96.0 Total 196.0	40 Skud 	21: *10.5 ↓ 22: *10.5 → 23: 10.0 ↗ 24: 9.1 → 25: 9.4 ↓ 26: 9.9 ↓ 27: 9.8 ↓ 28: 9.6 → 29: *10.3 ↗ 30: *10.6 ← <hr/> Serie 95.0 Total 291.0
-------------	---	-------------	--

40 Skud 	31: 9.6 ↗ 32: *10.5 ↑ 33: *10.4 ↗ 34: *10.5 ↓ 35: 9.5 ↓ 36: 9.3 ↗ 37: *10.3 ← 38: 9.7 ↑ 39: *10.4 ↓ 40: 9.8 → <hr/> Serie 95.0 Total 386.0		
-------------	---	--	--

Prøve 	Prøve 	11: *10.7 ↘ 12: 9.3 → 13: *10.3 ↗ 14: *10.2 ↗ 15: *10.6 ↖
Serie 95.0	Serie 49.0	
Total 0.0	Total 0.0	

40 Skud 	40 Skud 	11: *10.6 ↘ 12: 10.0 ↑ 13: *10.8 ↘ 14: *10.4 ↖ 15: *10.8 ↖ 16: *10.5 ↗ 17: *10.5 → 18: *10.6 ↗ 19: 9.6 ↘ 20: 9.4 ↘
Serie 96.0	Serie 98.0	
Total 96.0	Total 194.0	

40 Skud 	40 Skud 	21: *10.3 ↗ 22: 9.7 ↖ 23: *10.4 ↖ 24: *10.2 ↖ 25: *10.7 ↗ 26: *10.5 ↖ 27: 10.1 ↖ 28: 9.7 ↖ 29: *10.4 ↗ 30: 9.9 ↘
Serie 97.0	Serie 96.0	
Total 291.0	Total 387.0	

<p>Prøve</p>	<p>1: 9.4 ↖ 2: 8.8 ↗ 3: *10.2 ↗ 4: 9.3 ↓ 5: 9.6 ← 6: *10.8 ↑ 7: 9.5 ↗ 8: *10.7 ↓ 9: *10.4 ↗ 10: 10.0 ↗</p> <p>Serie 94.0 Total 0.0</p>	<p>Prøve</p>	<p>11: 9.9 ↘ 12: 9.5 ↘ 13: *10.6 → 14: 10.1 → 15: 9.9 → 16: *10.4 ← 17: 9.9 ↑ 18: *10.3 ↖ 19: *10.4 ↗ 20: *10.6 ←</p> <p>Serie 96.0 Total 0.0</p>
--------------	--	--------------	---

<p>Prøve</p>	<p>21: *10.2 ←</p> <p>Serie 10.0 Total 0.0</p>	<p>40 Skud</p>	<p>1: 10.0 ← 2: *10.3 ↗ 3: 10.1 ↓ 4: 10.0 → 5: 10.1 ↗ 6: *10.2 ↓ 7: 10.1 ↓ 8: 9.8 ↓ 9: *10.4 ↑ 10: *10.3 ←</p> <p>Serie 99.0 Total 99.0</p>
--------------	--	----------------	---

<p>40 Skud</p>	<p>11: *10.5 ↑ 12: *10.3 ↓ 13: *10.7 ← 14: *10.7 → 15: *10.8 ↓ 16: 9.8 ↘ 17: *10.5 ↓ 18: *10.7 ← 19: *10.4 ↑ 20: 9.3 ↓</p> <p>Serie 98.0 Total 197.0</p>	<p>40 Skud</p>	<p>21: *10.4 ↘ 22: 10.1 ↘ 23: *10.2 ↘ 24: 10.1 ↑ 25: 10.0 ↗ 26: *10.3 ↖ 27: *10.9 ↓ 28: *10.9 ↓ 29: 10.1 ↖ 30: 9.8 ↓</p> <p>Serie 99.0 Total 296.0</p>
----------------	--	----------------	--

<p>40 Skud</p>	<p>31: 10.1 ↖ 32: 9.6 ↖ 33: *10.6 ↘ 34: *10.5 → 35: *10.6 → 36: *10.8 → 37: 10.0 ↓ 38: *10.3 ↘ 39: *10.6 ← 40: 10.1 ↗</p> <p>Serie 99.0 Total 395.0</p>		
----------------	---	--	--

Prøve 	1: 9.8 ↙ 2: 9.3 ↘ 3: *10.2 ↔ 4: 10.1 → 5: *10.2 ↓ 6: *10.4 ↙ 7: 9.3 → 8: *10.4 ↘ 9: 9.9 ↘ 10: *10.7 ↙ <hr/> Serie 96.0 Total 0.0	Prøve 	11: 9.5 ↖ 12: 9.7 → 13: 10.0 ↗ 14: 10.1 → <hr/> Serie 38.0 Total 0.0
-----------	---	-----------	---

40 Skud 	1: 10.0 ↖ 2: 9.2 ↖ 3: *10.6 ↙ 4: *10.7 ↓ 5: 8.8 ↗ 6: 9.5 ↘ 7: *10.5 ↗ 8: 9.6 ← 9: 9.4 ↘ 10: *10.8 ↙ <hr/> Serie 94.0 Total 94.0	40 Skud 	11: *10.4 ↓ 12: 8.8 ↖ 13: 9.2 ← 14: *10.4 ↙ 15: *10.5 ↗ 16: *10.7 ↓ 17: *10.7 ↗ 18: *10.6 → 19: 6.7 ← 20: 9.7 ← <hr/> Serie 92.0 Total 186.0
-------------	--	-------------	---

40 Skud 	21: *10.2 ↗ 22: 9.0 ↘ 23: 10.0 ↘ 24: 10.1 ↗ 25: 9.6 → 26: 9.4 → 27: 9.9 ↖ 28: *10.3 ↘ 29: 9.6 ↗ 30: *10.2 ↓ <hr/> Serie 95.0 Total 281.0	40 Skud 	31: *10.7 ↗ 32: *10.7 ↗ 33: 10.1 → 34: 10.0 ← 35: 9.5 → 36: 8.1 ← 37: 10.0 ↓ 38: *10.8 ↘ 39: 9.8 ↖ 40: *10.2 → <hr/> Serie 96.0 Total 377.0
-------------	---	-------------	--

Prøve 	1: 9.6 → 2: 9.6 ↓ 3: 9.4 ↓ 4: 10.1 ↓ 5: 9.7 ← 6: 10.1 ← 7: *10.4 → 8: 9.9 ← 9: *10.3 ↘ 10: 9.9 → <hr/> Serie 94.0 Total 0.0	Prøve 	11: *10.8 ↗ 12: *10.3 ↗ 13: 10.0 ↗ <hr/> Serie 30.0 Total 0.0
---	--	---	---

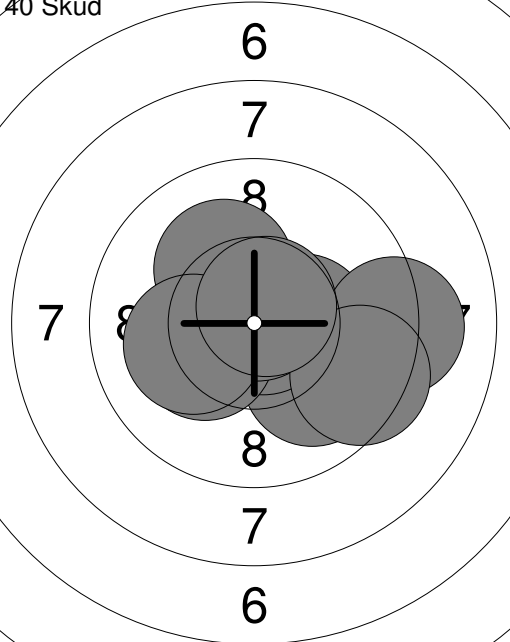
40 Skud 	1: *10.3 → 2: 9.9 ↓ 3: 9.2 → 4: *10.8 → 5: *10.2 ↘ 6: *10.8 ↗ 7: 9.4 → 8: *10.2 ↘ 9: 10.1 ← 10: *10.7 ↗ <hr/> Serie 97.0 Total 97.0	40 Skud 	11: *10.3 ↗ 12: *10.6 ↓ 13: *10.4 ← 14: *10.2 ↘ 15: *10.6 ↘ 16: 10.1 ← 17: 10.0 ↑ 18: *10.7 ↘ 19: *10.5 → 20: *10.4 ↑ <hr/> Serie 100.0 Total 197.0
--	--	--	--

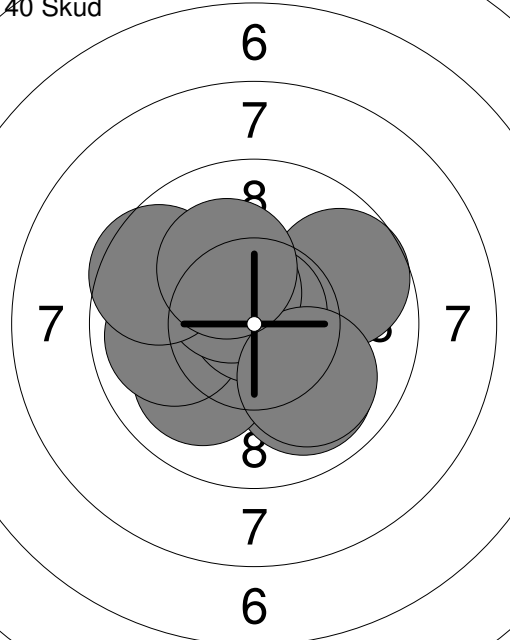
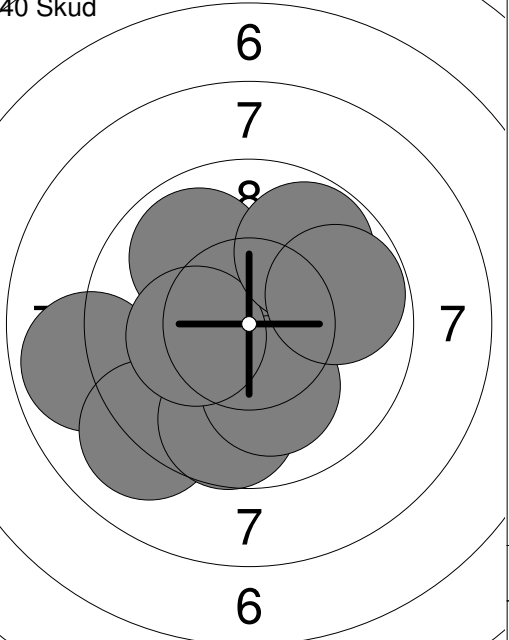
40 Skud 	21: 9.7 → 22: 9.9 ↓ 23: *10.7 ← 24: 10.0 ↘ 25: 9.9 ← 26: *10.8 ↗ 27: *10.5 ↘ 28: 10.0 ↘ 29: 9.6 ← 30: *10.2 ↘ <hr/> Serie 96.0 Total 293.0	40 Skud 	31: 8.9 ← 32: *10.3 ↘ 33: 9.9 ↘ 34: 9.1 ↘ 35: *10.3 ↓ 36: 9.7 ↓ 37: 10.1 ↓ 38: *10.3 ← 39: 9.8 ↗ 40: 9.8 → <hr/> Serie 93.0 Total 386.0
---	---	---	--

<p>Prøve</p>	<p>1: 7.8 ↓ 2: 6.9 ↓ 3: *10.6 ↓ 4: 9.0 ↓ 5: 9.1 ↓ 6: 9.2 ↓ 7: *10.7 → 8: *10.6 ↓ 9: *10.5 → 10: *10.8 ↓</p>	<p>Prøve</p>	<p>11: 9.0 ↓ 12: 10.0 ↗ 13: *10.3 →</p>
Serie 90.0		Serie 29.0	
Total 0.0		Total 0.0	

<p>40 Skud</p>	<p>1: *10.7 ↗ 2: 9.8 → 3: 10.1 ↖ 4: *10.6 ↖ 5: *10.3 ↖ 6: *10.3 ↖ 7: 9.8 → 8: *10.3 ↑ 9: 9.6 ↖ 10: 9.7 →</p>	<p>40 Skud</p>	<p>11: 10.0 ↓ 12: *10.3 ↗ 13: 10.1 → 14: 10.1 ↖ 15: 10.0 ↗ 16: *10.5 ↖ 17: *10.3 ↓ 18: *10.2 ↑ 19: *10.9 ↓ 20: 8.0 →</p>
Serie 96.0		Serie 98.0	
Total 96.0		Total 194.0	

<p>40 Skud</p>	<p>21: 10.0 ↑ 22: 10.0 → 23: *10.2 ↗ 24: *10.3 ↓ 25: 9.7 ↖ 26: *10.2 ↑ 27: 10.0 ← 28: 9.9 ↑ 29: 10.1 ↓ 30: *10.3 ↗</p>	<p>40 Skud</p>	<p>31: 9.8 ↖ 32: 10.1 → 33: 9.6 → 34: 10.1 ↗ 35: *10.4 ↓ 36: 9.9 ↖ 37: *10.4 ↓ 38: 10.1 ↑ 39: *10.8 ↓ 40: 9.8 ↗</p>
Serie 98.0		Serie 96.0	
Total 292.0		Total 388.0	

Prøve 	1: 9.9 ↓ 2: 10.1 ↙ 3: *10.7 ↘ 4: *10.4 ↘ 5: 9.8 ← 6: 9.9 → 7: *10.4 ↖ 8: *10.6 → 9: *10.6 ← 10: 9.9 ↓ <hr/> Serie 96.0 Total 0.0	Prøve 	11: 10.0 ↑ 12: *10.6 ↘ 13: *10.7 ↑	<hr/> Serie 30.0 Total 0.0
---	---	---	--	-------------------------------

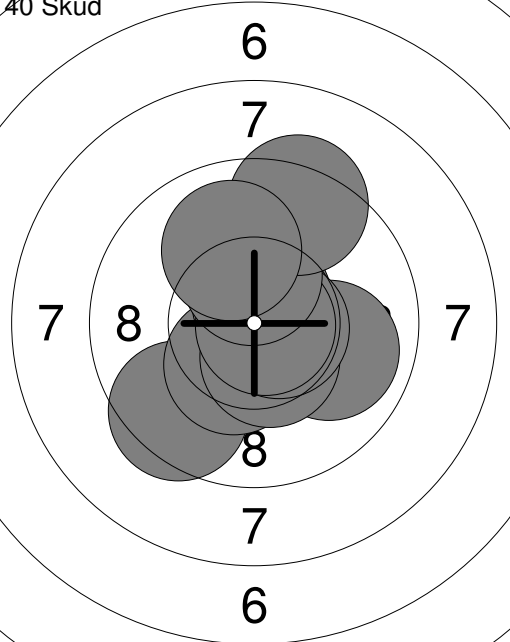
40 Skud 	1: 9.9 → 2: 9.5 ↘ 3: *10.4 ↘ 4: *10.5 ↘ 5: *10.6 ↑ 6: *10.6 → 7: *10.8 → 8: *10.3 ↑ 9: 9.3 ↑ 10: 10.0 ↑ <hr/> Serie 97.0 Total 97.0	40 Skud 	11: 9.2 ↙ 12: *10.6 ↑ 13: *10.3 ↘ 14: *10.4 ↖ 15: *10.3 ↖ 16: 10.0 ↑ 17: *10.4 ↑ 18: 9.6 → 19: *10.6 ↘ 20: *10.8 ↑	<hr/> Serie 98.0 Total 195.0
--	--	--	---	---------------------------------

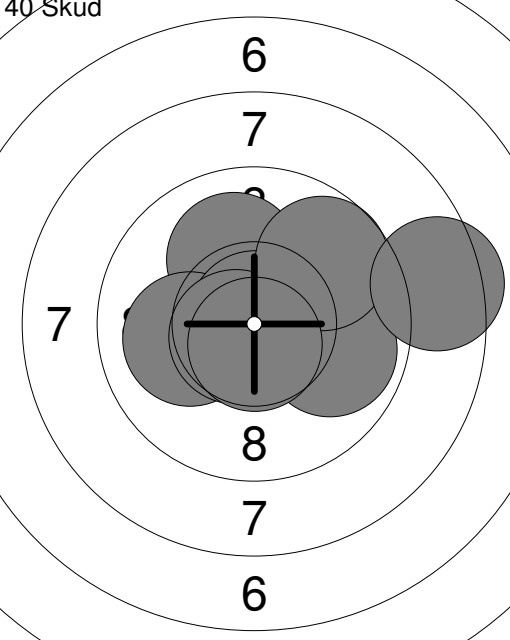
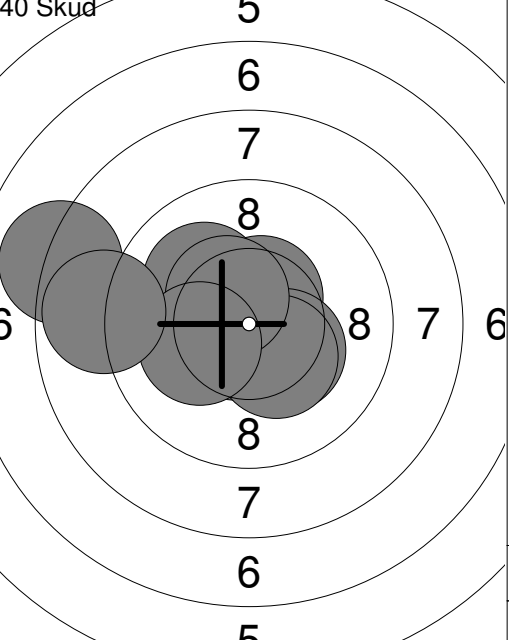
40 Skud 	21: *10.8 ↖ 22: 10.1 ↑ 23: *10.7 ↘ 24: 10.1 ← 25: *10.9 ↑ 26: 9.9 → 27: *10.7 ↘ 28: 9.7 ↗ 29: 8.4 → 30: *10.7 ↘ <hr/> Serie 96.0 Total 291.0	40 Skud 	31: *10.5 ↑ 32: *10.3 ↘ 33: *10.5 ↖ 34: 10.1 ↖ 35: *10.7 ↘ 36: *10.3 ↘ 37: *10.4 ↖ 38: 8.1 ← 39: *10.2 ↘ 40: 8.8 ←	<hr/> Serie 96.0 Total 387.0
---	---	---	---	---------------------------------

Prøve 	Prøve 	11: *10.2 ↙ 12: 10.1 → 13: *10.6 ↓ <hr/> Serie 30.0 Total 0.0
1: 9.6 ↓ 2: *10.2 ↓ 3: 10.1 ↑ 4: *10.5 ↑ 5: *10.5 → 6: 9.9 ← 7: *10.6 ↓ 8: 9.9 → 9: *10.5 ↘ 10: *10.4 ↙ <hr/> Serie 97.0 Total 0.0	11: *10.4 → 12: 9.9 ← 13: *10.2 → 14: 10.1 ↖ 15: *10.3 ↙ 16: *10.4 ↗ 17: *10.6 ↑ 18: *10.8 ↑ 19: *10.2 ↘ 20: *10.7 ↓ <hr/> Serie 99.0 Total 197.0	

40 Skud 	40 Skud 	21: *10.5 ↙ 22: 9.8 → 23: *10.6 ↑ 24: *10.2 ↙ 25: 10.0 ↓ 26: 9.8 → 27: *10.2 ↘ 28: *10.3 ↙ 29: 9.7 ↓ 30: *10.2 ↗ <hr/> Serie 97.0 Total 294.0
1: *10.3 ↘ 2: *10.3 ↗ 3: *10.6 ↙ 4: 9.8 ↗ 5: *10.6 ↙ 6: 9.8 → 7: *10.2 ↙ 8: *10.5 ↓ 9: *10.6 ↘ 10: *10.5 ↘ <hr/> Serie 98.0 Total 98.0	31: 9.8 ← 32: *10.3 ↙ 33: 8.7 → 34: *10.3 ↙ 35: *10.3 ↑ 36: *10.7 ↘ 37: *10.2 → 38: 9.0 ← 39: 9.8 ↙ 40: 10.1 ↑ <hr/> Serie 95.0 Total 389.0	

40 Skud 	40 Skud 	31: 9.8 ← 32: *10.3 ↙ 33: 8.7 → 34: *10.3 ↙ 35: *10.3 ↑ 36: *10.7 ↘ 37: *10.2 → 38: 9.0 ← 39: 9.8 ↙ 40: 10.1 ↑ <hr/> Serie 95.0 Total 389.0
21: *10.5 ↙ 22: 9.8 → 23: *10.6 ↑ 24: *10.2 ↙ 25: 10.0 ↓ 26: 9.8 → 27: *10.2 ↘ 28: *10.3 ↙ 29: 9.7 ↓ 30: *10.2 ↗ <hr/> Serie 97.0 Total 294.0	31: 9.8 ← 32: *10.3 ↙ 33: 8.7 → 34: *10.3 ↙ 35: *10.3 ↑ 36: *10.7 ↘ 37: *10.2 → 38: 9.0 ← 39: 9.8 ↙ 40: 10.1 ↑ <hr/> Serie 95.0 Total 389.0	

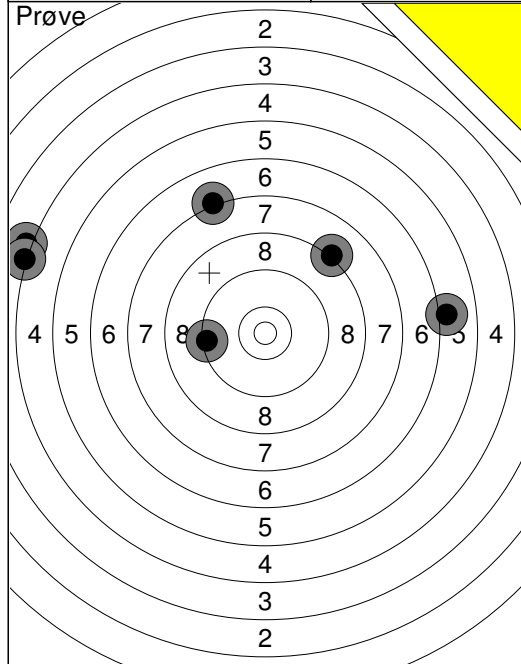

1:	4.1	↖
2:	9.4	←
3:	7.2	↗
4:	8.2	↗
5:	4.2	←
6:	6.0	→
Serie		38.0
Total		0.0

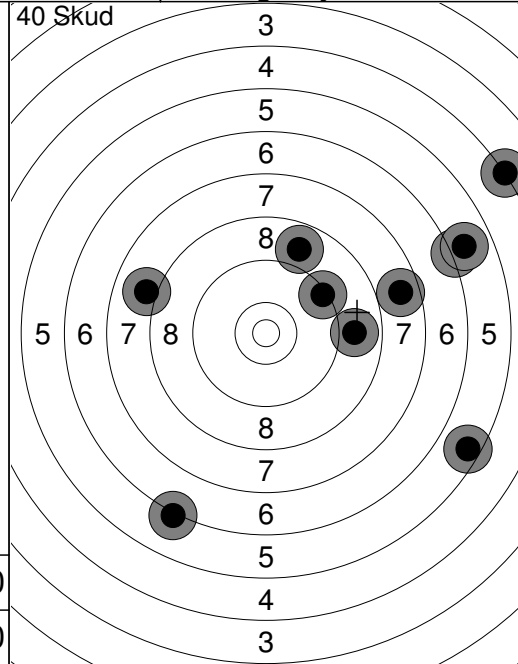

1:	9.4	↗
2:	8.9	→
3:	4.2	↗
4:	7.7	→
5:	6.2	↗
6:	5.5	↘
7:	8.8	↗
8:	5.9	↗
9:	8.0	←
10:	6.2	↘
Serie		66.0
Total		66.0

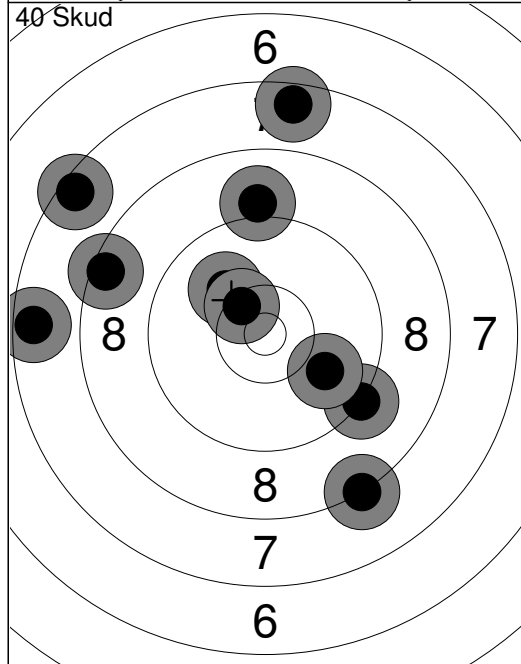

11:	8.4	↖
12:	7.5	↖
13:	10.1	↗
14:	7.5	←
15:	9.2	↘
16:	7.5	↗
17:	8.2	↘
18:	9.0	↗
19:	9.9	↘
20:	*10.4	↗
Serie		84.0
Total		150.0

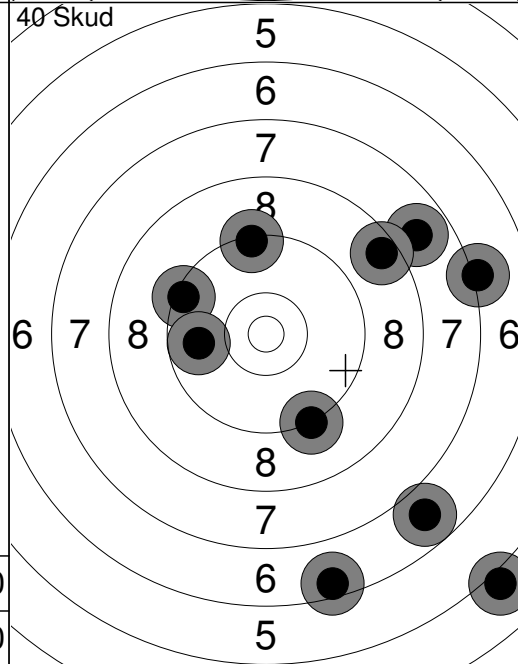

21:	7.8	↗
22:	9.3	↗
23:	8.5	↗
24:	6.8	↘
25:	9.2	↘
26:	9.4	←
27:	9.8	←
28:	6.5	↘
29:	7.1	→
30:	5.0	↘
Serie		75.0
Total		225.0

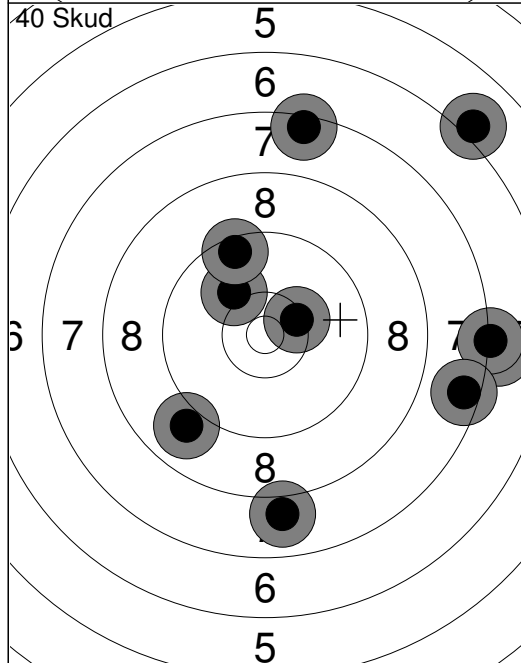

31:	7.0	→
32:	7.2	→
33:	6.0	↗
34:	*10.4	↗
35:	7.9	↘
36:	7.5	→
37:	10.1	↖
38:	7.4	↗
39:	8.9	↖
40:	9.5	↗
Serie		78.0
Total		303.0

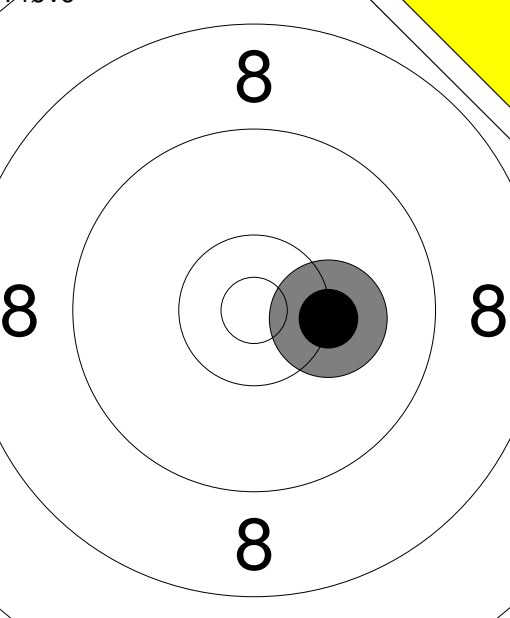
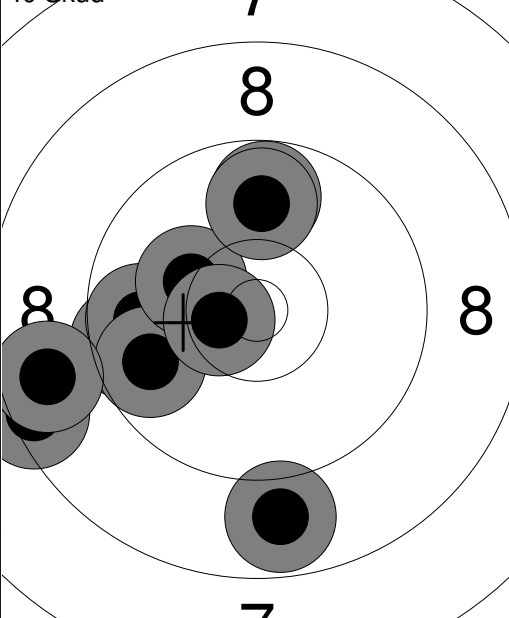
Prøve 	1: 10.2 → 40 Skud 	1: 9.6 ← 2: 9.8 ← 3: 9.8 ← 4: 9.8 ↑ 5: 10.2 ↖ 6: 8.9 ↓ 7: *10.6 ↖ 8: 8.5 ← 9: 9.9 ↑ 10: 8.7 ←
Serie 10.0	Serie 89.0	
Total 0.0	Total 89.0	

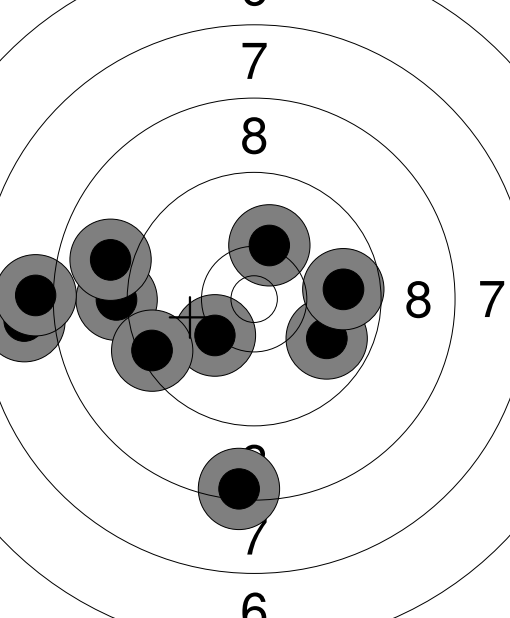
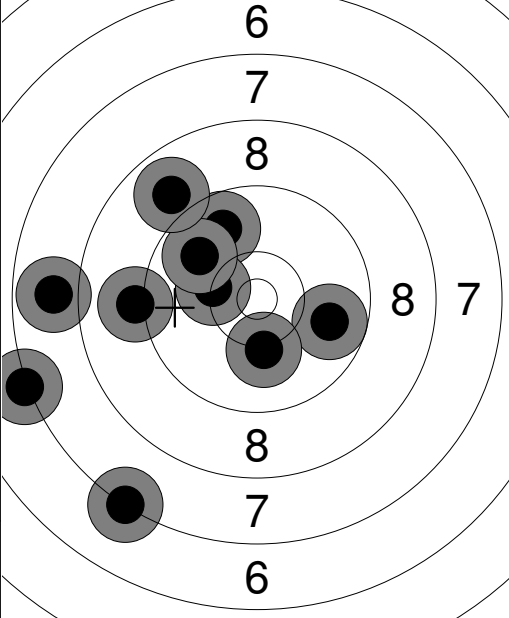
40 Skud 	40 Skud 	11: 9.8 → 12: 10.2 ↙ 13: 7.8 ← 14: 8.4 ↓ 15: 9.7 → 16: 9.1 ← 17: 8.9 ← 18: 9.4 ← 19: 10.2 ↑ 20: 8.0 ←
Serie 87.0	Serie 85.0	
Total 176.0	Total 261.0	

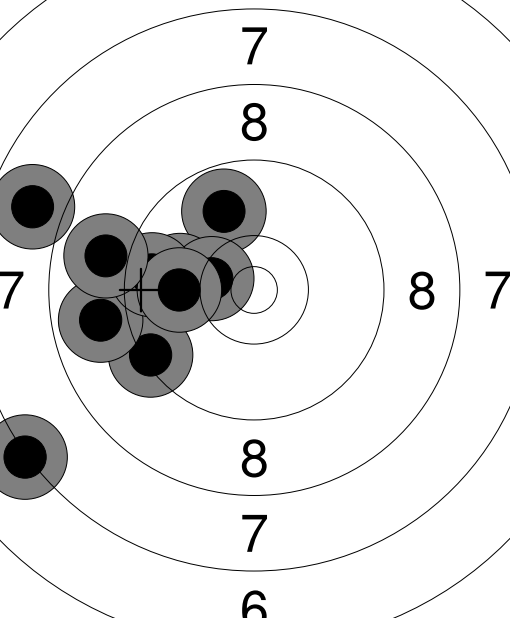
40 Skud 	31: 9.8 ↑ 32: 9.3 ← 33: 7.2 ↙ 34: 7.8 ← 35: 8.9 ← 36: 10.0 ↖ 37: *10.4 ↖ 38: 9.6 ← 39: 10.0 ↖ 40: 8.9 ←	
Serie 87.0		
Total 348.0		